

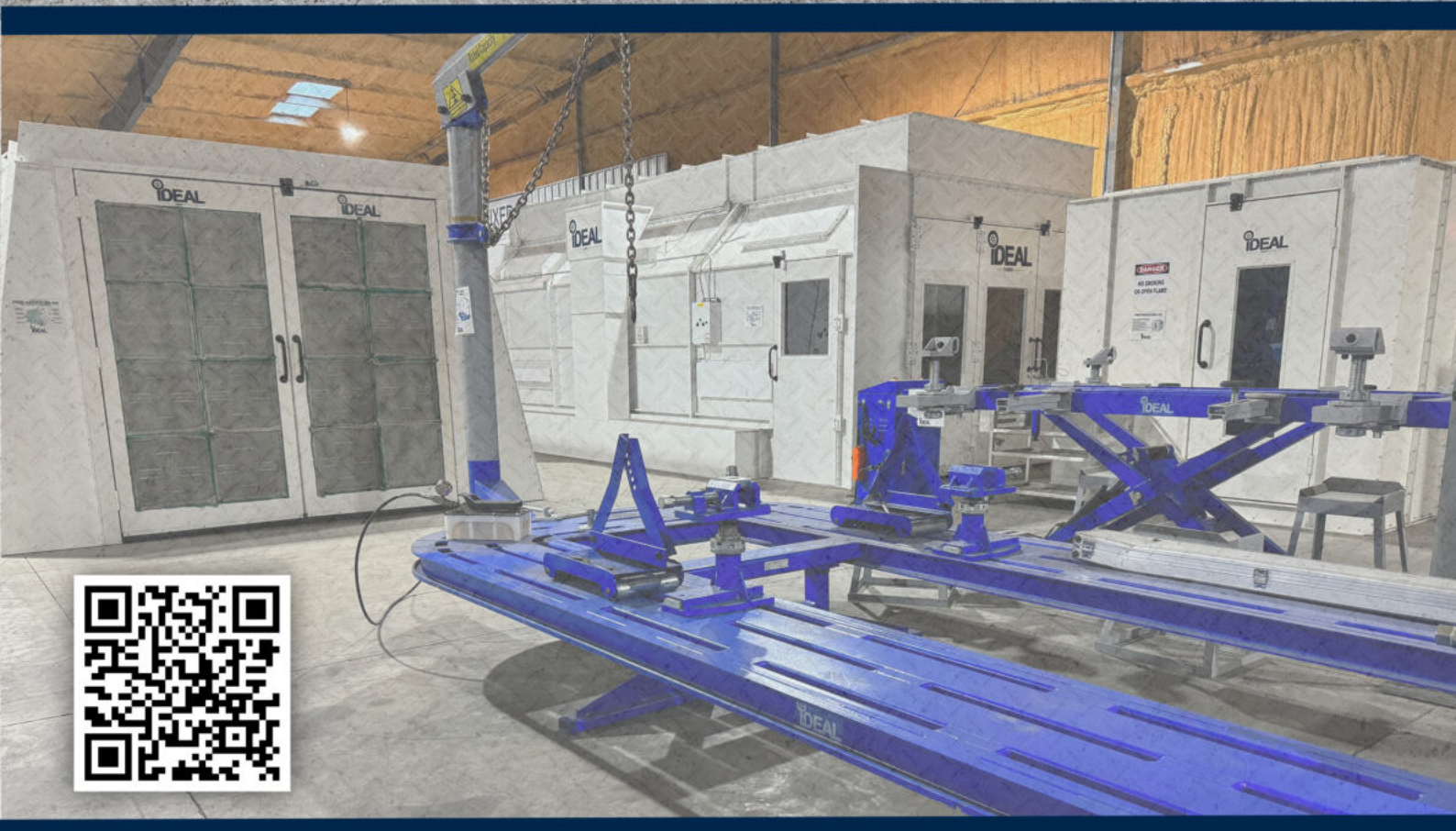

TUXEDO

Distributors, LLC.
Automotive Equipment & Accessories

2024 CATALOG



ALI CERTIFIED TWO POST LIFTS



TP10KAC-DX TWO POST CLEAR FLOOR



- 10,000 LBS CAPACITY
- ALI CERTIFIED
- BI-SYMMETRIC ARM DESIGN
- RUBBER DOOR GUARDS
- 3 STAGE FRONT ARMS
- DIRECT DRIVE PULL CYLINDERS
- SINGLE POINT LOCK RELEASE
- SPIN UP LOW PROFILE LIFT PADS
- STACKABLE ADAPTERS INCLUDED
- EXTERNAL HOSE GUARDS
- DURO CERTIFIED POWER UNIT
MET, UL, CSA LISTED

TP12KSC-DX TWO POST CLEAR FLOOR



- 12,000LBS CAPACITY
- ALI CERTIFIED
- SYMMETRIC TWO STAGE ARMS
- RUBBER DOOR GUARDS
- DIRECT DRIVE PUSH CYLINDERS
- SINGLE POINT LOCK RELEASE
- SPIN UP LIFT PADS 5" PAD HEIGHT
- STACKABLE ADAPTERS INCLUDED
- EXTERNAL HOSE GUARDS
- DURO CERTIFIED POWER UNIT
MET, UL, CSA LISTED

BI-SYMMETRIC™ Asymmetric or Symmetric Configuration

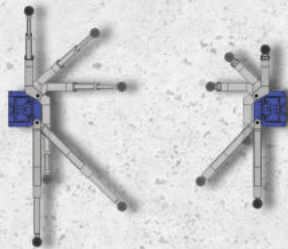

180° Front Arm Full Rotation

TP10KAC-DX



Single Point Lock Release



Low Profile Pads with 2.6" & 5" Adapters

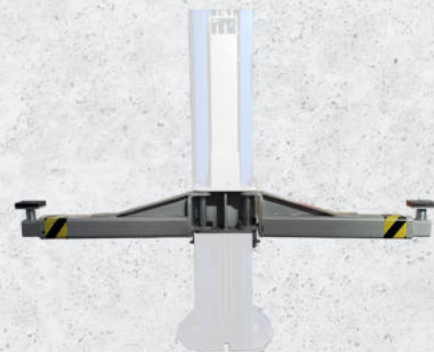

Symmetric Swing Arms Configuration

TP12KSC-DX

ALI CERTIFIED TWO POST LIFTS & SPECIFICATIONS

LAUNCH TECH USA

TLT210-XT TWO POST CLEAR FLOOR

- 10,000LBS CAPACITY
- DIRECT DRIVE CYLINDERS
- RUBBER DOOR GUARDS
- OUTER HOSE GUARDS
- SINGLE POINT LOCK RELEASE
- HEAVY DUTY ARM RESTRAINT SYSTEM
- DOUBLE TELESCOPING SCREW PADS
- ADJUSTABLE COLUMN HEIGHT
- ADJUSTABLE COLUMN WIDTH
- STANDARD OR ROTATED COLUMNS
- STACKABLE LIFT PAD EXTENSIONS
- 3 STAGE FRONT ARMS
- AVAILABLE **RED** OR **BLUE**



TLT211-AS TWO POST CLEAR FLOOR

- 11,000LBS CAPACITY
- DIRECT DRIVE CYLINDERS
- RUBBER DOOR GUARDS
- OUTER HOSE GUARDS
- SINGLE POINT LOCK RELEASE
- HEAVY DUTY ARM RESTRAINT SYSTEM
- DOUBLE TELESCOPING SCREW PADS
- ADJUSTABLE COLUMN HEIGHT
- STACKABLE LIFT PAD EXTENSIONS
- 3 STAGE FRONT ARMS
- AVAILABLE **RED** OR **BLUE**



Standard
Asymmetric

Rotated
Asymmetric



Standard
Asymmetric

SPECIFICATIONS

Lift Model	TP10KAC-DX	TP12KSC-DX	TLT210-XT	TLT211-AS
Capacity	10,000 lbs.	12,000 lbs.	10,000 lbs.	11,000 lbs.
Height Overall	144"	168-1/2"	145-1/2" / 149"	149"
Width Overall w/ Power Unit	145-1/2"	151-5/16"	Asymmetric: 138" Symmetric: 137"	137-7/8"
Max Lift Height	71"	75"	73"	75-5/8"
Width Between Columns	116"	122"	110" / 102"	108"
Min. Pad Height	4"	4-7/8"	4"	4"
Drive Thru Clearance	104"	109"	Asymmetric: 88" Symmetric: 98.4"	96"
Lifting Speed	50S	50S	50S	54S
Asymmetric / Symmetric	Bi-Symmetric	Symmetric	Symmetric/Asymmetric	Asymmetric
Clear Floor / Floor Plate	Clear Floor	Clear Floor	Clear Floor	Clear Floor
Short Arm Reach - min/max	23"-45"	37-5/8" - 57"	23-5/8"-43-1/2"	23-5/8"-39-7/16"
Long Arm Reach - min/max	41"-59"	Same	38-5/8"-61-7/8"	38-5/8"-61-7/8"
Narrow Bay Setting	NA	NA	Deduct 5.9"	N/A
Max Load Per Arm	2,500 lbs	3,000 lbs	2,500 lbs	2,750 lbs
Ship Weight	1,705 lbs	2,295 lbs	1,750 lbs	2,095 lbs
Power	220V - 20 AMP - 1 PH	220V - 20 AMP - 1 PH	208-230V-60Hz-1 PH	208-230V-60Hz-1 PH

TP9-CA
SPIN UP CRADLE ADAPTERS
EXCELLENT FOR LIFTING FROM FRAME
USE WITH TP9KF-TUX, TP9KAC-TUX



TP9KX-SPNCA
SPIN UP CRADLE ADAPTERS
EXCELLENT FOR LIFTING FROM FRAME
USE WITH TP9KFX, TP9KACX, TP9KSCX



TP11DX-SPNCA
SPIN UP CRADLE ADAPTERS
EXCELLENT FOR LIFTING FROM FRAME
USE WITH TP10KAC-DX TO MAINTAIN ALI
USE WITH TP11KC-DX



TP12SDX-SPNCA
SPIN UP CRADLE ADAPTERS
EXCELLENT FOR LIFTING FROM FRAME
USE WITH TP12KSC-DX ALI



TP12KF/15KCX-SPNCA
SPIN UP CRADLE ADAPTERS
EXCELLENT FOR LIFTING FROM FRAME
USE WITH TP12KF & TP15KCX



TLT240-SPNCA
LAUNCH, SPIN UP CRADLE ADAPTERS
SPIN UP CRADLE ADAPTERS (SET OF 4EA)
EXCELLENT FOR LIFTING FROM VEHICLE FRAME
FOR USE WITH TLT240SB & TLT240SC

TWO POST LIFTS

ECONOMICAL TWO POST AUTO LIFTS

TP9KF-TUX TWO POST FLOOR PLATE

- 9,000 LBS CAPACITY
- SYMMETRIC ARMS
- CHAIN DRIVE CYLINDERS
- AUTO ARM RESTRAINT SYSTEM
- LOW PROFILE DROP-IN FOOT PADS
- SADDLE PAD ADAPTORS (1 PAIR)
- STACKABLE ADAPTERS INCLUDED
- BLACK COLOR STANDARD
- DUAL POINT LOCK RELEASE



TP9KAC-TUX TWO POST CLEAR FLOOR

- 9,000 LBS CAPACITY
- ASYMMETRIC ARMS
- CHAIN DRIVE CYLINDERS
- DUAL POINT LOCK RELEASE
- AUTO ARM RESTRAINT SYSTEM
- LOW PROFILE DROP-IN LIFT PADS
- SADDLE PAD ADAPTORS (1 PAIR)
- STACKABLE ADAPTERS INCLUDED
- BLACK COLOR STANDARD



COMMERCIAL TWO POST AUTO LIFTS

TP9KFX TWO POST FLOOR PLATE

- 9,000 LBS CAPACITY
- SYMMETRIC ARMS
- RUBBER DOOR GUARDS
- CHAIN DRIVE CYLINDER
- DUAL POINT LOCK RELEASE
- SPIN UP LIFT PADS
- STACKABLE ADAPTERS INCLUDED



TP9KACX TWO POST CLEAR FLOOR

- 9,000 LBS CAPACITY
- ASYMMETRIC ARMS
- RUBBER DOOR GUARDS
- CHAIN DRIVE CYLINDER
- DUAL POINT LOCK RELEASE
- SPIN UP LIFT PADS
- STACKABLE ADAPTERS INCLUDED



TP9KSCX TWO POST CLEAR FLOOR

- 9,000 LBS CAPACITY
- SYMMETRIC ARMS
- RUBBER DOOR GUARDS
- CHAIN DRIVE CYLINDER
- DUAL POINT LOCK RELEASE
- SPIN UP LIFT PADS
- STACKABLE ADAPTERS INCLUDED



PROFESSIONAL TWO POST AUTO LIFTS

TLT240SB-R TWO POST FLOOR PLATE

- 9,000 LBS CAPACITY
- CHAIN DRIVE CYLINDERS
- RUBBER DOOR GUARDS
- HOSE GUARDS
- DUAL POINT LOCK RELEASE
- HEAVY DUTY ARM RESTRAINT SYSTEM
- DOUBLE TELESCOPING SCREW PADS
- STACKABLE FOOT PAD ADAPTERS INCLUDED



TLT240SC-R TWO POST CLEAR FLOOR

- 9,000 LBS CAPACITY
- CHAIN DRIVE CYLINDERS
- RUBBER DOOR GUARDS
- HOSE GUARDS
- DUAL POINT LOCK RELEASE
- HEAVY DUTY ARM RESTRAINT SYSTEM
- DOUBLE TELESCOPING SCREW PADS
- ADJUSTABLE COLUMN WIDTH
- STANDARD OR ROTATED ASYMMETRIC COLUMNS
- STACKABLE FOOT PAD ADAPTERS
- 3 STAGE FRONT ARMS



TP11KC-DX TWO POST CLEAR FLOOR

- 11,000 LBS CAPACITY
- BI-SYMMETRIC ARM DESIGN
- RUBBER DOOR GUARDS
- 3 STAGE FRONT ARMS
- DIRECT DRIVE PULL CYLINDER
- SINGLE POINT LOCK RELEASE
- SPIN UP LOW PROFILE LIFT PADS
- STACKABLE ADAPTERS INCLUDED
- HOSE GUARDS

BI-SYMMETRIC™ Asymmetric or Symmetric Configuration

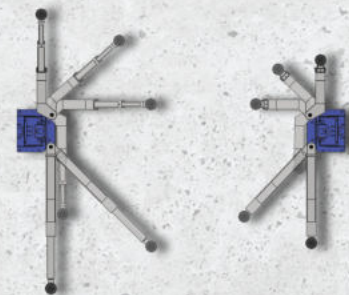

180° Front Arm Full Rotation

TWO POST LIFTS & SPECIFICATIONS

HEAVY DUTY TWO POST AUTO LIFTS

TP12KFX TWO POST FLOOR PLATE

- 12,000 LBS CAPACITY
- SYMMETRIC ARM
- CHAIN DRIVEN CYLINDER
- SPIN-UP PADS AND ADAPTERS
- LOW PAD HEIGHT

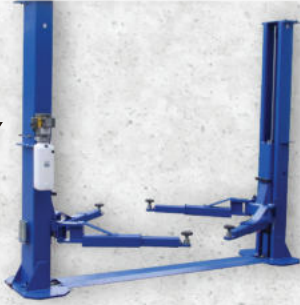

TP12KC-D TWO POST CLEAR FLOOR

- 12,000 LBS CAPACITY
- SYMMETRIC ARMS
- DIRECT PUSH DRIVE
- SINGLE POINT AIR LOCK RELEASE
- HEIGHT ADAPTERS
- HOSE GUARDS



TP15KCX TWO POST CLEAR FLOOR

- 15,000 LBS CAPACITY
- SYMMETRIC ARMS
- CHAIN DRIVEN CYLINDER
- HEAVY DUTY LOCK RELEASE
- SPIN-UP PADS AND ADAPTERS
- LOW PAD HEIGHT



Lift Model	TP9KF-TUX	TP9KAC-TUX	TP9KFX	TP9KACX	TP9KSCX
Capacity	9,000 lbs.	9,000 lbs.	9,000 lbs.	9,000 lbs.	9,000 lbs.
Height Overall	112"	142-11/16"	111-7/8"	142-7/8"	142-7/8"
Width Overall w/ Power Unit	141"	141"	134-5/8"	138"	138"
Max Lift Height	72"	72"	72"	72"	72"
Width Between Columns	110-3/8"	110-3/8"	110-3/8"	113-5/8"	113-5/8"
Min. Pad Height	4"	4"	4"	4"	4"
Drive Thru Clearance	101-11/16"	93-11/16"	101"	96"	104"
Lifting Speed	50S	50S	50S	50S	50S
Asymmetric / Symmetric	Symmetric	Asymmetric	Symmetric	Asymmetric	Symmetric
Clear Floor / Floor Plate	Floor Plate	Clear Floor	Floor Plate	Clear Floor	Clear Floor
Short Arm Reach - min/max	31"-45"	29"-41"	31"-45"	29"-41"	31"-45"
Long Arm Reach - min/max	Same	37"-57"	Same	37"-57"	Same
Narrow Bay Setting	NA	NA	NA	NA	NA
Max Load Per Arm	2,250 lbs.	2,250 lbs.	2,250 lbs.	2,250 lbs.	2,250 lbs.
Ship Weight	1,295 lbs.	1,390 lbs.	1,270 lbs.	1,370 lbs.	1,370 lbs.
Power	220V-20 AMP-1PH	220V-20 AMP-1PH	220V-20 AMP-1PH	220V-20 AMP-1PH	220V-20 AMP-1PH

Lift Model	TLT240SB-R	TLT240SC-R	TP11KC-DX	TP12KFX	TP12KC-D	TP15KCX
Capacity	9,000 lbs.	9,000 lbs.	11,000 lbs.	12,000 lbs.	12,000 lbs.	15,000 lbs.
Height Overall	113"	151"	144"	121-1/2"	165"	179-3/8"
Width Overall w/ Power Unit	133"	Asymmetric: 140" Symmetric: 134"	145-1/2"	147-7/8"	151"	148-3/8"
Max Lift Height	73"	73"	71"	76-1/2"	72"	76-1/2"
Width Between Columns	108"	108"	116"	120-5/16"	122"	120-3/4"
Min. Pad Height	4"	4"	4"	5"	5.5"	5"
Drive Thru Clearance	98"	Asymmetric: 95" Symmetric: 98"	104"	109"	109"	109-3/8"
Lifting Speed	50S	50S	50S	45S	50S	45S
Asymmetric / Symmetric	Symmetric	Symmetric/Asymmetric	Asymmetric/Symmetric	Symmetric	Symmetric	Symmetric
Clear Floor / Floor Plate	Floor Plate	Clear Floor	Clear Floor	Floor Plate	Clear Floor	Clear Floor
Short Arm Reach - min/max	31-1/2"-47-1/4"	23-5/8"-43-1/2"	23" - 45"	37" - 52-1/2"	37-5/8" - 56-3/4"	37" - 52"
Long Arm Reach - min/max	Same	34"-54"	41" - 57"	Same	Same	Same
Narrow Bay Setting	NA	Deduct 5.9"	NA	NA	NA	NA
Max Load Per Arm	2,250 lbs.	2,250 lbs.	2,750 lbs.	3,000 lbs.	3,000 lbs.	3,750 lbs.
Ship Weight	1,445 lbs.	1,600 lbs.	1,705 lbs.	2,460 lbs.	2,295 lbs.	2,575 lbs.
Power	220V-20 AMP-1PH	220V-20 AMP-1PH	220V-20 AMP-1PH	220V-20 AMP-1PH	220V-20 AMP-1PH	220V-20 AMP-1PH

SPECIAL TWO POST ACCESSORIES

TPDX-GM19-SPNCA

GM 2019+ WIDE SPIN-UP CRADLE ADAPTERS

- SPIN UP CRADLE ADAPTERS (SET OF 2EA)
- WIDER DESIGN FOR 2019+ GM SILVERADO & SIERRA LIGHT DUTY TRUCKS
- EXCELLENT FOR LIFTING FRONT VEHICLE FRAME
- FOR USE WITH TP12KFX & TP15KCX



TP12KFX/ 15KCX-GM19-SPNCA

GM 2019+ WIDE SPIN-UP CRADLE ADAPTERS

- SPIN UP CRADLE ADAPTERS (SET OF 2EA)
- WIDER DESIGN FOR 2019+ GM SILVERADO & SIERRA LIGHT DUTY TRUCKS
- EXCELLENT FOR LIFTING FRONT VEHICLE FRAME
- FOR USE WITH TP12KFX & TP15KCX



COMMERCIAL FOUR POST LIFTS



FP14KC-X

IDEAL, 14K-4 POST SERVICE LIFT 182.5" WB

- 14,000 LBS CAPACITY
- HIGH PERFORMANCE COMMERCIAL SERVICE LIFT
- DURABLE, HIGH QUALITY CABLE LIFT SYSTEM
- EXTENDED RISE HEIGHT
- 182.5" MAX WHEELBASE
- 18 LOCKING HEIGHT POSITIONS
- 20" WIDE RUNWAYS
- NARROW & WIDE RUNWAY MOUNTING POSITIONS
- SINGLE POINT PNEUMATIC LOCK RELEASE
- FULLY ADJUSTABLE LOCK STOPS FOR EASY LEVELING
- SLACK CABLE SAFETY DEVICES
- SELF-CHOCKING APPROACH RAMP W/ NYLON ROLLERS
- WHEEL CHOCKS (1 PAIR)
- DURABLE POWDER COAT FINISH

FP14KC-X 'OPTIONAL' ACCESSORIES

- 7,000 LBS. ROLLING BRIDGE JACK - HIGH MOUNT (RAJ-7K-H)
- INTERNAL AIRLINE KIT W/ FLR (FP14KCX-ALK)
- 24" RUNWAY EXTENSION KIT (FP14KCX-24EXTKIT)
- BOLT ON RUNWAY ALIGNMENT KIT (FP14KCX-ALIGNKIT)

FP14KC-X 'ADDITIONAL' FEATURES

- ABLE TO EXTEND RUNWAYS 24" W/ EXTENSION KIT!
- CONVERTS TO ALIGNMENT LIFT W/ 'QUICK MOUNT' 'BOLT-ON' ALIGNMENT KIT!
- DESIGNED FOR FAST & SIMPLE INSTALLATION & SERVICE REQUIREMENTS!
- GREASE ZERKS APPLIED FOR ALL CABLE PULLEYS & SHAFT ASSEMBLIES FOR DURABILITY!
- HIGH QUALITY DURO POWER UNIT W/ UL LISTED MOTOR & ELECTRICAL COMPONENTS!

FP14KAC-X

IDEAL, 14K-4 POST ALIGNMENT LIFT 182.5" WB

- 14,000 LBS. CAPACITY
- HIGH PERFORMANCE COMMERCIAL ALIGNMENT LIFT
- DURABLE, HIGH QUALITY CABLE LIFT SYSTEM
- EXTENDED RISE HEIGHT
- 'BOLT-ON' RUNWAY ALIGNMENT KIT
- 166.7" MAX ALIGNMENT WHEELBASE (2 WHEEL)
- 157" MAX ALIGNMENT WHEELBASE (4 WHEEL)
- 182.5" MAX SERVICE WHEELBASE
- 18 LOCKING HEIGHT POSITIONS
- FULL WIDTH REAR WHEEL SLIP PLATES
- TWO TURNTABLE POSITIONS W/ SPACER COVERS
- 20" WIDE RUNWAYS
- NARROW & WIDE RUNWAY MOUNTING POSITIONS
- SINGLE POINT PNEUMATIC LOCK RELEASE
- FULLY ADJUSTABLE LOCK STOPS FOR EASY LEVELING
- SLACK CABLE SAFETY DEVICES
- SELF-CHOCKING APPROACH RAMP W/ NYLON ROLLERS
- WHEEL CHOCKS (1 PAIR)
- DURABLE POWDER COAT FINISH

FP14KAC-X 'INCLUDED' ACCESSORIES

- INTERNAL AIRLINE KIT W/ FLR
- HD CARBON STEEL TURNTABLES - 4.5K CAP. EA.
- ROLLOFF SPACERS FOR HD TURNTABLES



FP14KAC-X 'OPTIONAL' ACCESSORIES

- 7,000 LBS. ROLLING BRIDGE JACK - HIGH MOUNT (RAJ-7K-H)
- 24" RUNWAY EXTENSION KIT (FP14KCX-24EXTKIT)
- 24" ALIGNMENT SPACER KIT (FP14KCX-24ALIGNSPCRKIT)

COMMERCIAL FOUR POST KITS & ACCESSORIES

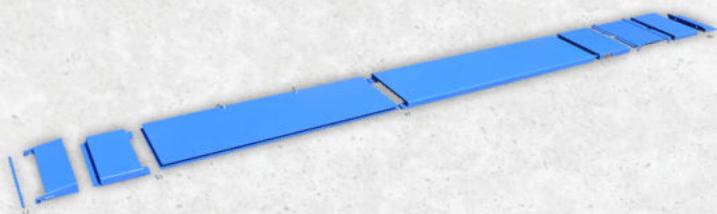

FP14KCX-ALIGNKIT

IDEAL, ALIGNMENT KIT 'BOLT-ON' (FP14KC-X)

- DESIGNED TO EASILY CONVERT FP14KC-X SERVICE LIFT TO ALIGNMENT LIFT
- ALIGNMENT KIT QUICKLY 'BOLTS' TO PRE-DRILLED HOLES IN FP14KC-X RUNWAYS
- PROVIDES ALIGNMENT MAX WHEELBASES OF 166.7" (2 WHEEL) & 157" (4 WHEEL)
- INCLUDES REAR SLIP PLATES, CENTER PANELS, TURNTABLE SADDLES & CUTOUTS
- PROVIDES LEVEL SURFACE FROM TURNTABLE CUTOUTS TO REAR SLIP PLATES
- NYLON SADDLE PADS FOR EASY & PROTECTIVE TURNTABLE POSITIONING
- TURNTABLE SPACER COVERS & EXTENDED HEIGHT WHEEL STOPS
- INCLUDES ALL MOUNTING HARDWARE
- DURABLE POWDER COAT FINISH
- TURNTABLES NOT INCLUDED

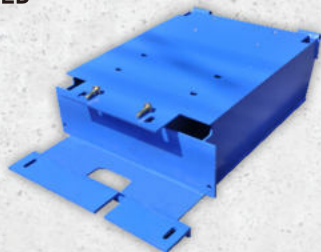

FP14KCX-ALK

IDEAL, AIR LINE KIT W/ FRL (FP14KC-X)

- DESIGNED FOR USE W/ FP14KC-X LIFT & RAJ-7K MODELS
- INCLUDES COILED HOSES, AIR TUBING, AIR FITTINGS & QUICK DISCONNECT FITTINGS TO RAJS.
- INCLUDES FRL (FILTER, REGULATOR & LUBRICATOR)
- QUICK RETRO-FIT INSTALLATION DESIGN
- INCLUDES ALL MOUNTING HARDWARE

FP14KCX-24EXTKIT

IDEAL, 24" RUNWAY EXTENSION KIT (FP14KC-X)

- SET OF TWO
- DESIGNED FOR USE W/ FP14KC-X & FP14KAC-X LIFT MODELS
- LENGTHENS RUNWAYS BY 24" FOR EXTENDED WHEELBASE REQUIREMENTS
- EXTENDS FP14KC-X LIFT TO 206" MAX SERVICE WHEELBASE
- EXTENDS FP14KAC-X *LIFT TO 190.7" MAX ALIGNMENT WHEELBASE (2 WHEEL) *24" EXT. ALIGNMENT SPACER KIT REQUIRED TO EXTEND' FP14KAC-X ALIGNMENT RUNWAYS
- EASY 'BOLT-ON' DESIGN
- INCLUDES ALL MOUNTING HARDWARE
- DURABLE POWDER COAT FINISH



FP14KCX-24ALIGNSPCRKIT

IDEAL, 24" EXTENSION, ALIGNMENT SPACER KIT (FP14KC-X)

- SET OF TWO
- DESIGNED FOR USE W/ FP14KCX-ALIGNKIT
- PROVIDES ELEVATED & LEVEL SURFACE FROM EXTENSIONS TO RUNWAYS
- EASY 'BOLT-ON' DESIGN
- INCLUDES ALL MOUNTING HARDWARE
- DURABLE POWDER COAT FINISH



TURNTABLE-FP14KCX-DK

IDEAL, TURNTABLES & 'ROLLBACK' SPACERS SETS - DELUXE KIT

- DESIGNED FOR USE W/ FP14KCX-ALIGNKIT & FP14KAC-X LIFT
- INCLUDES TURNTABLE-FP14KCX (SET OF TWO)
- INCLUDES TURNTABLE, ROLLBACK SPACERS (SET OF TWO)

TURNTABLE-RBSPCR

IDEAL, TURNTABLE, ROLLBACK SPACER SET (FP14KC-X)

- SET OF TWO
- DESIGNED FOR USE W/ TURNTABLE-FP14KCX
- PROVIDES LEVEL SURFACE TO RUNWAYS
- HANDLES FOR EASY POSITIONING
- METAL CONSTRUCTION
- DURABLE POWDER COAT FINISH

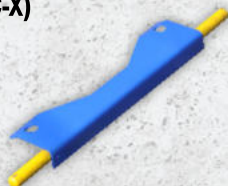

TURNTABLE-FP14KCX

IDEAL, TURNTABLE SET (FP14KC-X)

- SET OF TWO
- HIGH QUALITY CONSTRUCTION
- HD CARBON STEEL TOP PLATE
- HANDLES ON BASE FOR EASY POSITIONING
- 14"L X 14"W X 1.5"H
- 9,000 LBS TOTAL SET CAPACITY



COMMERCIAL FOUR POST LIFTS

COMMERCIAL SERVICE FOUR POST LIFTS

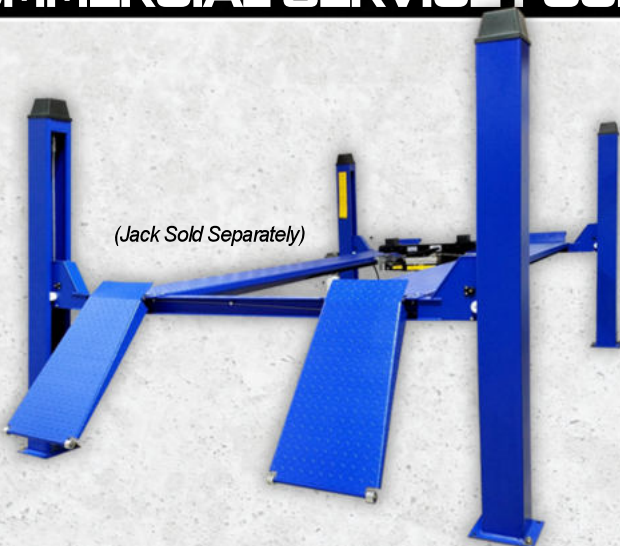

FP12K-K FOUR POST SERVICE LIFT

- 12,000 LBS CAPACITY
- CABLE DRIVEN
- 176" MAX WHEELBASE
- SINGLE POINT MANUAL LOCK RELEASE
- ADJUSTABLE LOCKING POSITIONS
- SLACK CABLE SAFETY
- NO OVERHEAD OBSTRUCTIONS
- POWDER COAT FINISH

FP14K FOUR POST SERVICE LIFT

- 14,000 LBS CAPACITY
- CHAIN DRIVEN
- 182" MAX WHEELBASE
- SINGLE POINT PNEUMATIC LOCK RELEASE
- POWDER COAT FINISH



FOUR POST LIFT ACCESSORIES



RAJ-7K-H

7K ROLLING AIR JACK - (HIGH MOUNT)

- 7,000 LBS. CAPACITY
- HIGH MOUNT DESIGN FOR LOW POSITION JACK RAILS
- ADJUSTABLE HEIGHT ROLLER BODY ASSEMBLIES
- DUAL 'SPRING LOADED' ROLLER BODY OPERATION
- SMOOTH 'ON-RAIL' ROLLING W/ ROLLER BEARING WHEELS
- TELESCOPING & LOCKING SUPPORT ARMS
- AIR / HYDRAULIC OPERATION
- PROTECTIVE SKIRTS
- TWO LOCKING HEIGHT POSITIONS
- RUBBER HEIGHT ADAPTERS (SET OF 2EA)



RAJ-7K-L

7K ROLLING AIR JACK - (LOW MOUNT)

- 7,000 LBS. CAPACITY
- LOW MOUNT DESIGN FOR HIGH POSITION JACK RAILS
- ADJUSTABLE HEIGHT ROLLER BODY ASSEMBLIES
- DUAL 'SPRING LOADED' ROLLER BODY OPERATION
- SMOOTH 'ON-RAIL' ROLLING W/ ROLLER BEARING WHEELS
- TELESCOPING & LOCKING SUPPORT ARMS
- AIR / HYDRAULIC OPERATION
- PROTECTIVE SKIRTS
- TWO LOCKING HEIGHT POSITIONS
- RUBBER HEIGHT ADAPTERS (SET OF 2EA)



(RAJ-8K-H SHOWN)

RAJ-8K-H & RAJ-8K-L

8K ROLLING AIR JACK - (HIGH MOUNT & LOW MOUNT)

- 8,000 LBS. CAPACITY
- LOW OR HIGH MOUNT MODEL CONFIGURATIONS
- ADJUSTABLE HEIGHT ROLLER BODY ASSEMBLIES
- DUAL 'SPRING LOADED' ROLLER BODY OPERATION
- SMOOTH 'ON-RAIL' ROLLING W/ ROLLER BEARING WHEELS
- PNEUMATIC AIR BAG OPERATION (2 BAGS)
- TWO LOCKING HEIGHT POSITIONS
- HEIGHT ADAPTERS (SETS OF 2EA)



'HIGH MOUNT'

BRACKET CONFIGURATIONS

UNIVERSAL ROLLER BODY BRACKET ASSEMBLIES
DESIGNED FOR EITHER HIGH MOUNT OR
LOW MOUNT APPLICATIONS



'LOW MOUNT'

TURNTABLE-25-152

ALIGNMENT LIFT TURNPLATES

- SET OF TWO
- ROUND PLATE DESIGN
- HEAVY DUTY
- 13" L X 13" W X 2" H
- 9,000 LBS TOTAL SET CAPACITY



COMMERCIAL FOUR POST SPECIFICATIONS

COMMERCIAL SERVICE FOUR POST LIFTS

Lift Model	FP12K-K	FP14K	FP14KC-X
Capacity	12,000 lbs.	14,000 lbs.	14,000 lbs.
Overall Length w/ Ramp	232-1/2"	237"	252-1/2"
Overall Width (Without Power Unit)	123"	123"	131-7/8"
Overall Width (With Power Unit)	134"	129"	142"
Overall Height	84"	99"	92-1/2"
Max Rise Height	67-1/2"	65-1/4"	77-1/2"
Min Height	7"	7-1/2"	7-7/8"
Width Between Posts	105"	108"	116-1/4"
Length Between Posts	177"	187"	196"
Width Between Runways	36-1/2"	41"	43" or 46"
Width of Runways	19"	20"	20"
Max Wheelbase	167"	182"	182-1/2"
Ramp Length	35"	30"	44"
Max. Clearance Under Runway	63-1/4"	60"	69-5/8"
Drive-Thru Clearance	87-1/2"	99"	96"
Base Plate	11" x 11"	10-1/2" x 10-1/2"	10-1/2" x 9"
Power Requirement	220V - 20 Amp - 1PH	220V - 20 Amp -	220V - 20 Amp -
Ship Weight	2,255 lbs.	2,615 lbs.	2,690 lbs.
Min Bay Size	15' x 23'	15' x 24'	15' x 25'

COMMERCIAL ALIGNMENT FOUR POST LIFTS

Lift Model	FP14KAC-X
Capacity	14,000 lbs.
Overall Length w/ Ramp	252-1/2"
Overall Width (Without Power Unit)	131-7/8"
Overall Width (With Power Unit)	142"
Overall Height	92-1/2"
Max Rise Height	79-1/2"
Min Height	9-7/8"
Width Between Posts	116-1/4"
Length Between Posts	196"
Width Between Runways	43" or 46"
Width of Runways	20"
Max Wheelbase	182-1/2"
Max. Align Wheelbase (2 Wheel)	166-3/4"
Min / Max. Align Wheelbase (4 Wheel)	103" / 157"
Ramp Length	44"
Max. Clearance Under Runway	69-5/8"
Drive-Thru Clearance	100"
Base Plate	10-1/2" x 9"
Power Requirement	220V - 20 Amp - 1PH
Ship Weight	3,810 lbs.
Min Bay Size	16' x 25'

WHEEL ALIGNMENT MACHINES



IWA-60-8500-K

IDEAL, 3D HD TRUCK MULTI-AXLE IMAGE WHEEL ALIGNER SYSTEM

- MULTI-AXLE FLOOR ALIGNMENT SYSTEM - NO VEHICLE LIFT REQUIRED!
- DESIGNED TO MEASURE LONG VEHICLES & VEHICLES WITH TRAILERS
- HIGH RESOLUTION / EXTENDED RANGE 3D CAMERAS
- INTEGRATED QUICK REFERENCE VEHICLE DATABASE FOR BOTH COMMERCIAL & PASSENGER VEHICLES
- INCLUDES HD TURNTABLE & DRIVE-ON RAMP SETS
- DYNAMIC LED GUIDE CHANGES SHAPE TO GUIDE TECHNICIAN
- DRIVE OVER PLATES FOR DRIVE-THRU CONFIGURATION
- CABINET TO SIDE FOR 'DRIVE-THRU' OR CENTERED FOR 'DEAD-END' SET-UP
- 8EA COMPACT TARGETS MEASURES UP TO FOUR AXLES AT ONCE
- 8EA ADJUSTABLE WHEEL CLAMPS FITS MOST STANDARD RIM SIZES
- CONVENIENT STORAGE STAND FOR WHEEL CLAMPS
- 2EA TOWERS WITH MAX VIEW RANGE OF 50 FT.
- RECALLS / PRINTS CURRENT & PAST INFO FOR CUSTOMIZED REPORTS
- HIGH QUALITY EUROPEAN DESIGN & MANUFACTURING
- OPTIONAL YEARLY VEHICLE SPEC UPDATES
- WIRELESS REMOTE CONTROL
- LIVE READING SCREENS FOR FRONT & REAR AXLE READINGS
- ILLUSTRATION DIAGRAMS & INTEGRATED HELP SYSTEM
- CUSTOMER DATABASE
- STEERING WHEEL HOLDER, BRAKE DEPRESSOR & WHEEL CHOCKS INCLUDED
- COMPUTER, MONITOR, KEYBOARD, MOUSE & COLOR PRINTER ALSO INCLUDED



**STORAGE STANDS FOR CLAMPS, HD TURNTABLES & DRIVE-ON RAMP SETS
ALL INCLUDED FOR NEW 3D HD TRUCK ALIGNER!!**

EXPERT USA PRODUCT & WARRANTY SUPPORT:



AVAILABLE EARLY 2024!

IWA-60-2000T-K

NEW

IDEAL, 3D IPRO IMAGE WHEEL ALIGNER SYSTEM

- WIDE SCOPE HIGH RESOLUTION 3D INDUSTRIAL GRADE CAMERAS
- MOBILE, MULTI BAY CAPABILITY
- .01 DEGREES ALIGNMENT ACCURACY
- DURABLE, POWDER-COATED METAL CABINET
- WIRELESS INTERNET SUPPORT
- FRONT, REAR, ALL READINGS SCREEN
- MULTIPLE 2D & 3D VIEWS OF LIVE READINGS SCREEN
- PRE-INSTALLED 25+ SPEC YEARS DATA BASE
- ADJUSTED DIAGRAMS & INTEGRATED HELP SYSTEM
- MULTI FUNCTIONAL LED GUIDE ON CAMERA BOOM
- MULTIPLE LANGUAGES
- WORKS WELL WITH MULTIPLE STYLE ALIGNMENT LIFTS
- REMOTE CONTROL INCLUDED
- STORAGE CABINET WITH SWIVEL POLY CASTERS & PRINTER DRAWER
- PC WINDOWS 10 W/ WIRELESS KEYBOARD, MOUSE AND 21.5" FLAT PANEL LCD MONITOR
- QUICK AND EASY ASSEMBLY
- BRACKETS TO STORE WHEEL ADAPTERS AND TARGETS
- BRACKETS TO STORE STEERING WHEEL HOLDER AND BRAKE PEDAL DEPRESSOR
- 12"-24" WHEEL CLAMPS
- COMPACT, LIGHT WEIGHT, AND DURABLE MAGNESIUM ALLOY TARGETS
- TARGETS EQUIPPED WITH PROTECTIVE PETROL AND OIL RESISTANT LAYER
- INCLUDES STEERING WHEEL HOLDER, BRAKE DEPRESSOR & WHEEL CHOCKS
- MOST CURRENT ALIGNMENT SOFTWARE SPECIFICATIONS AVAILABLE AT THE TIME OF PURCHASE
- SPEC DATABASE INCLUDES WHEEL ALIGNMENT SPECS, TIRE PRESSURE SPECS, AND ADJUSTMENT \ DIAGRAMS AND IMAGES FOR MORE THAN 60,000 VEHICLE MODELS
- ROLLING AND LIFTED COMPENSATION CAPABLE
- CONTROL WHEEL ALIGNER WITH SMART PHONE OR TABLET AS REMOTE (ANDROID ONLY)
- VIN CODE SCANNER CAPABLE (NOT INCLUDED)
- OPTIONAL YEARLY SPEC & SOFTWARE UPDATES AVAILABLE



EXPERT USA PRODUCT & WARRANTY SUPPORT:

STORAGE LIFTS



FP8K-B

BASIC STORAGE LIFT

- 8,000 LBS CAPACITY
- CABLE DRIVEN LIFT SYSTEM
- SINGLE POINT MANUAL LOCK RELEASE
- ADJUSTABLE LOCKING POSITIONS
- SLACK CABLE SAFETY
- STEEL APPROACH RAMPS
- FITS IN MOST RESIDENTIAL GARAGES
- NO CASTER KIT, DRIP TRAYS AND JACK TRAY



FP8K-DX

DELUXE STORAGE LIFT

- 8,000 LBS. CAPACITY
- CABLE DRIVEN LIFT SYSTEM
- SINGLE POINT MANUAL LOCK RELEASE
- ADJUSTABLE LOCKING POSITIONS
- SLACK CABLE SAFETY
- STEEL APPROACH RAMPS
- FITS IN MOST RESIDENTIAL GARAGES
- INCLUDES DRIP TRAYS, JACK TRAY & POLY CASTER KIT



FP8K-DX-XLT

DELUXE STORAGE LIFT

- 8,000 LBS. CAPACITY
- EXTENDED LIFT HEIGHT & LENGTH
- CABLE DRIVEN LIFT SYSTEM
- SINGLE POINT MANUAL LOCK RELEASE
- ADJUSTABLE LOCKING POSITIONS
- SLACK CABLE SAFETY
- STEEL APPROACH RAMPS
- FITS IN LARGER RESIDENTIAL GARAGES
- GREAT FOR STORAGE OF MANY FULL-SIZE TRUCKS
- INCLUDES DRIP TRAYS, JACK TRAY & POLY CASTER KIT



FP9K-DX-XLT

DELUXE STORAGE / SERVICE LIFT

- 9,000 LBS. CAPACITY
- EXTENDED RUNWAY LENGTH & DRIVE-THRU WIDTH
- CABLE DRIVEN LIFT SYSTEM
- SINGLE POINT MANUAL LOCK RELEASE
- ADJUSTABLE LOCKING POSITIONS
- SLACK CABLE SAFETY
- STEEL APPROACH RAMPS
- GREAT FOR STORAGE AND/OR GENERAL COMMERCIAL SERVICE
- INCLUDES DRIP TRAYS, JACK TRAY & POLY CASTER KIT

SINGLE POST



SP-6K-SS

SINGLE POST STORAGE LIFT

UPDATED

- 6,000 LBS. CAPACITY
- UPDATED W/ 3" WIDER RUNWAY DRIVE-ON CLEARANCE AT 80.8"
- DESIGNED FOR MOST CARS & LIGHT TRUCKS
- DOUBLES VEHICLE STORAGE / PARKING SPACE
- LOW POST HEIGHT FOR LOW CEILING REQUIREMENTS
- NARROW & EXTENDED WIDE RUNWAY MOUNT POSITIONS
- LONG 31" RAMPS FOR LOW PROFILE VEHICLES
- COMMERCIAL GRADE HYDRAULIC CYLINDER & HD CHAIN
- ABLE TO INSTALL TO LIFT FROM RIGHT OR LEFT SIDE
- SINGLE POINT MANUAL LOCK RELEASE
- DURABLE POWDER-COAT FINISH
- ALSO GREAT FOR VEHICLE INSPECTIONS & MINOR SERVICE

STORAGE LIFT SCISSOR JACKS



SJ-35

SLIDING SCISSOR JACK

(Fits FP-8K Series Lifts)

- 3,500 LBS CAPACITY
- SLIDING OPERATION
- HAND PUMP (NO AIR REQ.)
- 3 LOCKING POSITIONS
- LOW PROFILE DESIGN
- COMPATIBLE WITH MANY STORAGE LIFT BRANDS
- INCLUDES LIFT PADS & HEIGHT EXTENSIONS



RJ-45

ROLLING SCISSOR JACK

(Fits FP9K-DX-XLT Lift)

- 4,500 LBS CAPACITY
- SMOOTH ROLLING OPERATION
- HAND PUMP (NO AIR REQ.)
- 3 LOCKING POSITIONS
- LOW PROFILE DESIGN
- JACK RAIL REQUIRED
- INCLUDES LIFT PADS & HEIGHT EXTENSIONS

STORAGE LIFT SPECIFICATIONS

Lift Model	FP8K-B	FP8K-DX	FP8K-DX-XLT	FP9K-DX-XLT	SP-6K-SS
Capacity	8,000 lbs.	8,000 lbs.	8,000 lbs.	9,000 lbs.	6,000
Overall Length w/ Ramp	207-5/16"	207-5/16"	222-1/2"	239"	188"
Overall Width (Outside Base Plates)	103-1/2"	103-1/2"	109-3/8"	123"	113-1/2"
Overall Height	86"	86"	94"	97"	110-1/4"
Lifting Height	74-3/4"	74-3/4"	82-1/4"	85"	81-3/16"
Width Between Posts	94-1/2"	94-1/2"	100-5/16"	111-1/2"	NA
Length of Runways	165-1/2"	165-1/2"	180-1/2"	188-1/2"	152"
Width of Runways	18-5/8"	18-5/8"	18-5/8"	20"	18-7/8"
Lifting Speed	90S	90S	100S	100S	90S
Max Clearance Under Track	70"	70"	78"	81"	77-3/16"
Cable Diameter	3/8"	3/8"	3/8"	3/8"	3/8"
Base Plate Size	10" x 12"	10" x 12"	10" x 12"	12" x 12"	52" x 39"
Lock Positions	10	10	12	11	19
Ship Weight	1,545 lbs.	1,705 lbs.	1,800 lbs.	2,354 lbs.	2,610 lbs.
Power	115V - 20 Amp - 1PH	115V - 20 Amp - 1PH	115V - 20 Amp - 1PH	115V - 20 Amp - 1PH	115V - 20 Amp - 1PH

STORAGE LIFT ACCESSORIES



DRIP TRAYS

Molded plastic trays used for catching leaks from getting on the bottom car when the lift is used for storage.

FP8K-DX-DT

- 37" WIDTH
- DESIGNED FOR FP8K-B, FP8K-DS & FP8K-DX LIFTS

FP8K-DS/DX-XLT-DT

- 42" WIDTH
- DESIGNED FOR FP8K-DS-XLT & FP8K-DX-XLT LIFTS
- DESIGNED FOR SP-6K-SS (WIDE RUNWAY POSITION)

FP9KDX-DT

- 39" WIDTH
- DESIGNED FOR FP9K-DX-XLT LIFT
- DESIGNED FOR SP-6K-SS (NARROW RUNWAY POSITION)



JACK TRAYS

Load bearing steel tray used as a tool or parts tray, also supports bottle jacks and jack stands.

FP8K-DS/DX-JT

- 37"W X 12"L
- DESIGNED FOR FP8K-B, FP8K-DS & FP8K-DX LIFTS

FP8K-DS/DX-XLT-JT

- 42"W X 12"L
- DESIGNED FOR FP8K-DS-XLT & FP8K-DX-XLT LIFTS

FP8K-DS/DX-XLT-JT

- 39"W X 12"L
- DESIGNED FOR FP9K-DX-XLT LIFTS



POLY CASTER KIT

Provides convenient & smooth FP8K lift portability, while unloaded.

FP8K-PLYCASTERKIT

- FP8K 6" POLY CASTER KIT
- DURABLE 6" POLY CASTER WHEELS
- HEAVY DUTY CASTER BRACKETS
- SET OF 4EA
- ALL HARDWARE INCLUDED
- DESIGNED FOR FP8K LIFT MODELS



DURO PU-90 BRKT KIT

DURO PU, 90 DEGREE BRACKET KIT

- RELOCATES DURO POWER UNIT TO SIDES OF COLUMN
- DESIGNED TO REDUCE OVERALL LIFT WIDTH
- (FP9K-DX-XLT) MOUNTS TO FRONT OR REAR POWER UNIT COLUMN
- (FP8K LIFTS) MOUNTS ONLY TO REAR POWER UNIT COLUMN
- DURABLE POWDER COAT FINISH
- ALL HARDWARE INCLUDED

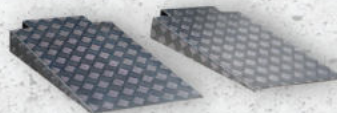

FP7K-4023

ALUMINUM RAMPS

- LIGHTWEIGHT ALUMINUM CONSTRUCTION
- DIAMOND PLATE PATTERN
- 37" LONG
- SET OF 2EA
- DESIGNED ONLY FOR FP8K LIFT MODELS

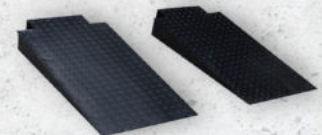

FP8K-STEELRAMPS

STEEL RAMPS

- DURABLE STEEL CONSTRUCTION
- DIAMOND PLATE PATTERN
- 36.75" LONG
- SET OF 2EA
- DESIGNED FOR FP8K LIFT MODELS

IMOBILE SINGLE COLUMN MULTI-LIFT



MSC-6KLP

IDEAL, IMOBILE SINGLE COLUMN LIFT

- 6,000 LBS CAPACITY
- LOW PROFILE DESIGN UNDER 4"
- DRIVE OVER RAMPS
- PORTABILITY
- RIGID BASE CONSTRUCTION
- SINGLE POINT LOCK RELEASE
- TELESCOPING TWO STAGE SWING ARMS
- DOUBLE TELESCOPING SCREW PADS
- STACKABLE PAD HEIGHT EXTENSIONS (2 SETS OF 4EA @ 2" & 4")
- HEAVY DUTY ARM RESTRAINTS
- 21 LOCKING POSITIONS
- DURABLE POWDER COAT FINISH



Lift Model	MSC-6KLP
Capacity	6,000 lbs.
Width Overall	45-3/16"
Height Overall	102-3/8"
Depth / Length Overall	101-9/16"
Lift Rise Height	72"
Minimum Ceiling Height	9'
Swivel Pad Height (Adj.)	3-15/16" - 6-5/16"
Platform Min. Height	NA
Main Side Arm Reach	19-11/16" - 26"
Offside Arm Reach	24-5/8" - 34"
Drive Over Height	3-15/16"
Platform Frame	NA
Platform Aluminum Deck	NA
Platform Structure	NA
Ship Weight	1,850 lbs.
Power	115V - 20 Amp - 1PH

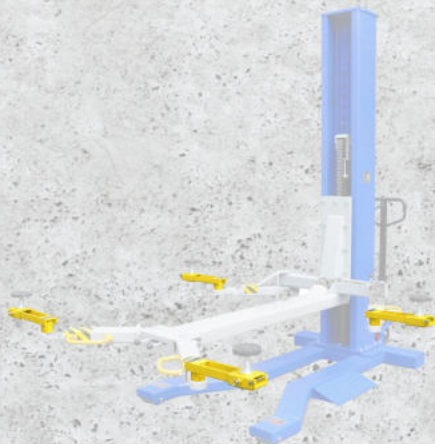

MSC-6KLP



UTVKIT-MSC-6KLP

IDEAL, UTV ADAPTOR KIT - MSC-6KLP

- 2,600 LBS CAPACITY (650 LBS PER ADAPTOR)
- IDEAL FOR UTILITY, POWER SPORT & RECREATIONAL TYPE VEHICLES
- PROVIDES ADJUSTABLE WIDTH / 360° BRACKET ROTATION
- EXTENDS SPIN-UP PAD LIFTING RANGE BY 8.9" PER ARM
- ADJUSTABLE WIDTH / LOCKING CRADLE BASE FOR LIFTING PADS
- KIT DESIGN USES MSC-6KLP 'SPIN-UP' LIFT PADS & HEIGHT EXTENSIONS
- QUICK & EASY INSTALLATION & REMOVAL
- DURABLE POWDER-COAT FINISH

Model Number	UTVKIT-MSC-6KLP
Total Kit Capacity (Set of 4ea)	2,600 lbs
Capacity Per Adaptor	650 lbs
Swivel Pad Adaptor Height - Min/Max	7-1/4" - 10-1/8"
Swivel Pad Adjustable Width Range	8-7/8"
Bracket Adaptor Length	14-3/8"
Bracket Adaptor Width	4"
Bracket Adaptor Height	3-1/2"
MS Arm & Adaptor Pad Range - Min/Max	19-11/16" - 91"
OS Arm & Adaptor Pad Range - Min/Max	26-3/16" - 82-5/16"
Ship Weight	58 lbs



View Video Here!

SINGLE COLUMN UTV & TURF LIFTS

SC-2K-UTV-X

NEW

IDEAL SINGLE COLUMN, UTV & MOWER STORAGE / SERVICE LIFT

- 2,000 LBS CAPACITY
- INNOVATIVE, MULTI-PURPOSE SINGLE COLUMN DUAL PLATFORM LIFT DESIGN
- IDEAL STORAGE SOLUTION FOR MOST SMALL TO MID-SIZED ATVs, UTVs, GOLF CARTS, RIDING LAWN MOWERS & ZERO TURNS
- ABILITY TO EASILY LOAD VEHICLES TO EITHER THE FRONT OR SIDE OF PLATFORMS
- ADJUSTABLE PLATFORMS PROVIDE UNDERCARRIAGE CLEARANCE TO EASILY SERVICE MOST RIDING LAWN MOWER DECKS & BLADES
- EASILY ADJUST & SECURE PLATFORMS TO DESIRED WIDTHS USING INTEGRATED 'AUTO-RETRACT' NYLON ROLLER BRACKETS & 'QUICK RELEASE' BOLSTER PINS
- EXTENDED RISE HEIGHT FOR INCREASED STORAGE & SERVICE CLEARANCES
- ALTERNATE POWER UNIT MOUNTING TO FRONT, SIDE OR REAR OF COLUMN
- 'QUICK REMOVAL' OUTER WHEEL STOP BARS
- 8EA STEEL 'QUICK ADJUST' PLATFORM SIDE RAMPS
- 2EA PLATFORM STEEL PIVOT RAMPS W/ NYLON ROLLERS
- SMOOTH & RELIABLE ELECTRIC / HYDRAULIC OPERATION W/ SINGLE POINT LOCK RELEASE
- DURABLE, HIGH QUALITY STEEL CONSTRUCTION
- LOW PROFILE PLATFORM DESIGN
- 20EA LOCKING HEIGHT POSITIONS
- DURABLE POWDER-COAT FINISH
- OPTIONAL MOTORCYCLE STORAGE W/ M-CHOCK & BASE PLATE KIT (SC-2K-UTV-MCBPK)



NEW

Lift Model	SC-2K-UTV-X
Capacity	2,000 lbs.
Width Overall	102"
Height Overall	106.3"
Depth / Length Overall	130"
Max Clearance Under Platforms	76.8"
Platforms Min Height	4.5"
Platforms Max Height	81.3"
Platform Width	17.75"
Platform Runway Width	12.2"
Platform Length	90.4"
Adjustable Platform Widths	52.7" to 84.6"
Adjustable Side Ramps Widths	35.4" to 67"
Locking Positions	20ea
Ship Weight	1,624 lbs.
Power	115V - 20 Amp - 1PH

Lift Model	SC-2K
Capacity	2,000 lbs.
Width Overall	64 5/8"
Height Overall	84-1/2"
Depth / Length Overall	69-1/2"
Lift Rise Height	58"
Minimum Ceiling Height	NA
Swivel Pad Height (Adj.)	NA
Platform Min. Height	2-3/4"
Main Side Arm Reach	NA
Offside Arm Reach	NA
Drive Over Height	NA
Platform Frame	64-1/2"W x 47-3/8"D
Platform Aluminum Deck	*36"W x 48"D
Platform Structure	64-1/2"W x 52-5/8"D
Ship Weight	605 lbs.
Power	115V - 20 Amp - 1PH

SC-2K

SINGLE POST PLATFORM STORAGE LIFT

- 2,000 LBS CAPACITY
- FITS IN MOST RESIDENTIAL GARAGES.
- MINIMAL SPACE, MAXIMUM STORAGE.
- PARK UNDER PLATFORM.
- LARGE STORAGE PLATFORM
- 58" OF CLEARANCE UNDER PLATFORM
- 115VAC POWER
- OPTIONAL MOTORCYCLE VISE ADAPTER



SC-2K-MVA

MOTORCYCLE VISE ATTACHMENT

- MOTORCYCLE VISE ADAPTER FOR SC-2K LIFT
- EXPANDS CAPABILITIES TO ALLOW FOR MOTORCYCLE SERVICE
- INCLUDES MOTORCYCLE VISE & 24" PLATFORM EXTENSION
- ALL HARDWARE INCLUDED

SCISSOR LIFTS



LR-26-PAD

LOW RISE PAD LIFT

- 6,000 LBS. CAPACITY
- DOLLY MOUNTED POWER UNIT
- LOW DRIVE OVER HEIGHT OF 3"
- AUTOMATIC SAFETY LOCK
- RUBBER SPACER BLOCKS INCLUDED
- EXCELLENT FOR TIRE AND WHEEL SERVICE
- OPTIONAL MR6K-38-SUV ADAPTER FOR SUV FRAME LIFTING



MR6.5K-38

MID RISE

SCISSOR LIFT

- 6,500 LBS CAPACITY
- PORTABLE LIFT DESIGN WITH WHEEL KIT & TOW BAR
- PORTABLE DOLLY MOUNTED POWER UNIT
- LOW DRIVE OVER HEIGHT OF 4"
- PNEUMATIC SINGLE POINT DOUBLE LOCK RELEASE SYSTEM
- LOAD BEARING FLIP-UP RUNWAY EXTENSIONS
- RUBBER SPACER BLOCKS INCLUDED
- OPTIONAL MR6K-38-SUV ADAPTER FOR SUV FRAME LIFTING



MR6K-48X

MID RISE SCISSOR LIFT

- 6,000 LBS CAPACITY
- 48" RISE HEIGHT
- PORTABLE DESIGN
- DOLLY MOUNTED POWER UNIT
- SINGLE POINT LOCK RELEASE
- EXTENDED ADJUSTABLE LIFT ARMS
- DURABLE RUBBERIZED LIFT PADS



PL6K

LOW RISE PIT LIFT

- 6,600 LBS CAPACITY
- FLOOR MOUNTED DESIGN
- LOW DRIVE OVER HEIGHT
- SINGLE POINT PNEUMATIC LOCK RELEASE
- PIT LIFT TO EXTEND QUICK LUBE SERVICES
- RUBBER SPACER BLOCKS INCLUDED
- OPTIONAL PL6K-ARMKIT FOR FRAME LIFTING
- OPTIONAL PL6K-HEIGHT-ADAPTER EXTENSIONS FOR FRAME LIFTING



LR-10K-TLPAD

NEW

LOW-RISE, COMMERCIAL PAD LIFT

- 10,000 LBS CAPACITY
- LOW RISE, COMMERCIAL GRADE PAD LIFT
- IDEAL FOR EXPRESS TIRE & WHEEL SERVICE
- SURFACE MOUNT INSTALL CONFIGURATION
- INTEGRATED OUTER FRAME & RAMPS PROVIDE DRIVE-ON & OFF CLEARANCE FOR WIDE VEHICLES
- LATCH RELEASE HANDLES ON EACH SIDE OF LIFT
- DUAL HYDRAULIC LIFT CYLINDERS
- METAL HOSE COVERS 55"L (2EA)
- STANDARD (4EA) HD MULTI-POSITION HEIGHT ADAPTERS & (4EA) 1.5" RUBBER PADS
- POWER UNIT PEDESTAL STAND
- OPTIONAL 220V POWER UNIT FOR INCREASED LIFT SPEED

Lift Model	LR-26-PAD	MR6.5K-38	MR6K-48X	PL6K
Capacity	6,000 lbs	6,500 lbs	6,000 lbs	6,600 lbs
Overall Length	86"	77"	96-1/2"	83-1/4"
Overall Width	73"	75-1/4"	39-5/8" - 62"	66"
Lifting Height	26"	38"	48-1/2"	28-1/2"
Min. Pad Height	3"	4"	7"	4-1/4"
Lifting Height with Adapters	30"	39-1/2"	54"	30"
Width Between Runways	35"	33-1/4"	NA	0 to 29-1/2"
Width of Runways	19"	18-3/16"	NA	18"
Lifting Speed	35S	40S	40S	40S
Pad Length	52"	56"	24"min / 83" max	53"
Ship Weight	955 lbs	1,355 lbs	945 lbs	770 lbs
Power	115V - 20 Amp - 1PH	115V - 20 Amp - 1PH	115V - 20 Amp - 1PH	115V - 20 Amp - 1PH
Air Supply	-	90 - 125 PSI	-	90 - 125 PSI

Lift Model	LR-10K-TLPAD
Capacity	10,000 lbs.
Overall Length	91"
Overall Width	88-5/8"
Max Rise Height	22-1/2"
Min Lift Height	4-1/4"
Max Lift Height w/ Tall Adapter	30-3/4"
Platform Pad Length	51-1/4"
Platform Pad Width	24"
Platforms Outer Width	70-3/4"
Platforms Forward Movement	15"
Platforms Locking Heights	13.5", 17.25", 21.5"
Lift Speed 115V / 220V	60S / 36S
Power	115V - 20 Amp - 1PH
Ship Weight	1,262 lbs.

SCISSOR LIFT ACCESSORIES



MR6K-38-SUV

MR6KSUV ADAPTER

- ALLOWS FRAME LIFTING WITH ADJUSTABLE LIFT PADS
- FOR USE WITH MR6K-38 AND LR-26-PAD
- HEIGHT ADAPTERS INCLUDED (2 SETS OF 4EA @ 3" & 6")



PL6K-ARMKIT

PL6K ARM ADAPTER KIT

- ALLOWS FRAME LIFTING WITH PAD CONTACTS
- ADAPTER ARMS LENGTH - (MIN / MAX 16.5" TO 23")
- DURABLE RUBBERIZED LIFT PADS
- FOR USE WITH PL6K LIFT



PL6K-HEIGHT ADAPTER

PL6K HEIGHT ADAPTER ARM KIT

- STACKABLE HEIGHT ADAPTERS FOR PL6K ARM KIT
- HEIGHT ADAPTERS INCLUDED (2 SETS OF 4EA @ 2.5" & 5")

TILT LIFT & ACCESSORIES

IDEAL 7000TLX™



View Video Here!



TLX-7000

IDEAL, LOW RISE, PORTABLE & STORABLE AUTOMOTIVE TILT LIFT, 7,000 LBS.

- HANDHELD ELECTRIC DRILL OPERATION, NO HYDRAULICS!
- LOW-PROFILE, LIGHTWEIGHT, PORTABLE & STORABLE
- EXCLUSIVE DUAL INDEPENDENT SAFETY LOCK BARS & PINS
- FULL OPERATION FROM EITHER SIDE OF LIFT
- TWIN 'DUAL-ACTION' PRECISION GEAR DRIVES
- ADJUSTABLE WIDTH PLATFORMS
- EASY TO USE & MAINTAIN
- DURABLE POWDER-COAT PAINT FINISH
- WEATHER RESISTANT FOR INDOOR OR OUTDOOR USE
- STANDARD WITH JACK STAND, PLATFORM RISERS, DRILL-DRIVE ADAPTERS, WALL MOUNT BRACKETS & MANUAL HANDLE W/ SOCKET ADAPTER (**POWER DRILL NOT INCLUDED)

Specifications	TLX-7000
Lift Capacity	7,000 lbs.
Overall Length	51-3/4"
Overall Width	64-3/8"
Min. Height	4-1/2"
Max Lift Height	22-1/2" - 23-1/2" w/ Risers
* Lift Speed	30 to 40 sec.
Lift Weight	111 lbs.
Platform Length & Width	31-1/2" x 7-1/4"
Outside / Platforms Widths	59-1/4" to 63-3/4"
Inside / Platforms Widths	44-1/2" to 49-1/4"
** Power (Corded Drill)	10 Amp - 120 VAC 1/2"
Ship Weight	214 lbs.



TLX-7000 INCLUDED ACCESSORIES

7000TLX PLATFORM RISERS PLATFORM RISERS



7000TLX GEAR DRIVE HANDLE & ADAPTOR MANUAL HANDLE W/ SOCKET ADAPTER



7000TLX JACK STAND TRIPOD JACK STAND



7000TLX WALL BRACKETS WALL MOUNT BRACKETS



7000TLX DRILL ADAPTOR DRILL-DRIVE ADAPTOR



OPTIONAL ACCESSORY TLX-7000-FLRAILKIT

TLX-7000 TILT LIFT, FLOOR RAIL KIT

- REQUIRED FOR INSUFFICIENT FLOOR SURFACES SUCH AS UNEVEN / ROUGH FLOORS
- REDUCES LIFTS WHEEL TRAVEL
- MARKS FOR POLISHED OR EXPOXIED TYPE FLOORS
- QUICK MOUNT EASY INSTALLATION



MOBILE COLUMN LIFTS & SPECIFICATIONS



MSC-18K-X HEAVY-DUTY MOBILE COLUMN LIFTS



- ALI CERTIFIED
- UP TO 108,000 LBS. CAPACITY
- 24VDC BATTERY OPERATION WITH ONBOARD CHARGING SYSTEM
- COMMUNICATION CABLE WITH RETRACTABLE CABLE REELS
- U-SHAPE WIRING CONFIGURATION FOR QUICK ENTRY AND EXIT
- CONVENIENT OPERATION FROM ANY COLUMN
- INDEPENDENT MECHANICAL LOCKING SYSTEM
- OPTICAL ENCODER FOR CONTINUOUS COLUMN SYNCHRONIZATION
- PORTABILITY FOR OUT OF THE WAY STORAGE USING PALLET JACK STYLE BASE
- EASY TO MOVE ADJUSTABLE FORKS
- EMERGENCY SHUTOFF SWITCH ON EACH COLUMN
- MASTER CONTROL PANEL FOR INDIVIDUAL OR PAIRED SYNCHRONIZED OPERATION
- SIMPLE OPERATION VIA LCD SCREEN AND KEYPAD
- LED LIGHT WITH MAGNETIC BASE (1 PER TWO COLUMNS)
- AVAILABLE IN TWO, FOUR OR SIX COLUMN CONFIGURATIONS
- OPTIONAL ALI CERTIFIED ACCESSORIES FOR EXPANDED SERVICE OPERATIONS

(BATTERIES NOT INCLUDED)



MSC-13K-B

HEAVY DUTY MOBILE COLUMN LIFT

- UP TO 78,000 LBS. CAPACITY
- EASY TO USE CONTROL PANEL
- OPERABLE FROM ANY COLUMN
- ADJUSTABLE FORK ACCOMMODATES MANY WHEEL SIZES
- DIRECT DRIVE HYDRAULIC CYLINDER
- INDEPENDENT MECHANICAL LOCKING SYSTEM
- BATTERY OPERATED WITH ONBOARD CHARGING SYSTEM
- EASILY MOVED FOR USE IN MULTIPLE BAYS
- SMALL FOOTPRINT ALLOWS FOR OUT OF THE WAY STORAGE
- AVAILABLE IN TWO, FOUR AND SIX COLUMN CONFIGURATION
- OPTIONAL ACCESSORIES FOR EXPANDED SERVICE OPERATIONS

(BATTERIES NOT INCLUDED)

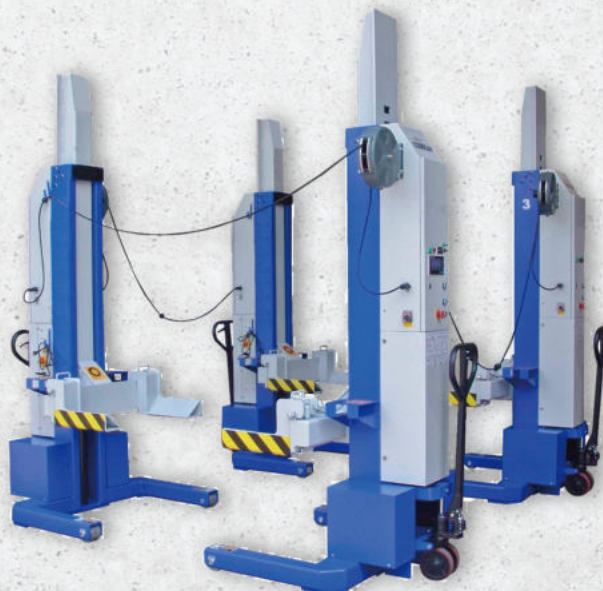

Lift Models	MSC-18K-X-236	MSC-18K-X-472	MSC-18K-X-6108	MSC-13K-B-226	MSC-13K-B-452	MSC-13K-B-678
Column Configurations	2 Column	4 Column	6 Column	2 Column	4 Column	6 Column
Capacity	36,000 lbs	72,000 lbs	108,000 lbs	26,000 lbs	52,000 lbs	78,000 lbs
AC Power (Input, Per Column)	100-140VAC, 60Hz, 1 PH			100-140VAC, 60Hz, 1 PH		
DC Power (Output, Per Column)	24VDC			24VDC		
Lifting Height	67.1"			67.1"		
Column Heights - Min/Max	Min. 88.6" / Max. 155.5"			Min. 88.6" / Max 155.5"		
Overall Width	44.1"			44.1"		
Fork Adjustable Range	12.6"- 22"			6.3" - 22"		
Fork Length	17.9"			14"		
Fork to Column Clearance	10"			9.3"		
Rise Time	100S			75S		
Descent Time	60S			60S		
Maximum Distance between Columns	32' 8"			32.8'		
Minimum Concrete Surface Strength	3000 PSI			3000 PSI		
Noise Level	70 dB(A)			70 dB(A)		
Set-Up / Operation	Indoors			Indoors		
Battery Type (Not included)	12VDC Sealed Deep Cycle Battery (BCI Group 31, AH-105)			12VDC Sealed Deep Cycle Battery (BCI Group 31, AH-105)		
Ship Weight	1,584 lbs per Column			1,210 lbs per Column		

MOBILE COLUMN LIFT ACCESSORIES



Included Adapters

MSC18KX-CRSBM

IDEAL, MSC CROSS BEAM

- ALLI CERTIFIED
- 22,000 LBS TO 33,000 LBS MAX SUPPORT CAPACITY
- ALLOWS FOR WHEELS FREE SERVICE WITH FRAME-ENGAGING LIFTING
- REQUIRES TWO MSC-18KX COLUMN OPERATION
- ADJUSTABLE WIDTH & HEIGHT PILLAR SUPPORTS
- STANDARD WITH HD STANDARD, AXEL & CRADLE CONTACT PAD ADAPTERS (1 PR EA.)
- POLY CASTERS & TOW BAR INCLUDED
- USED INDIVIDUALLY OR IN PAIRS WITH TWO OR FOUR COLUMN LIFT CONFIGURATIONS
- ALSO WORKS WITH MSC-13K-B LIFT



MSC18KX-LTVAK

IDEAL, MSC-18KX LIGHT TRUCK VEHICLE ADAPTER KIT

- ALLI CERTIFIED
- 20,000 LBS MAX SUPPORT CAPACITY (10,000 LBS PER ADAPTER)
- ALLOWS FOR WHEELS FREE SERVICE WITH FRAME-ENGAGING LIFTING
- FRAME-ENGAGING 'END' LIFTING FOR FRONT & REAR OF MOST VEHICLES
- REQUIRES TWO MSC-18KX COLUMN OPERATION
- ADJUSTABLE WIDTH PILLAR SUPPORTS
- STANDARD HD SWIVEL / RUBBER CONTACT PADS
- USED IN PAIRS ONLY WITH TWO COLUMN LIFT CONFIGURATION
- WORKS ONLY WITH MSC-18KX LIFT



MSC13KB-LTVAK

IDEAL, MSC-13KB LIGHT TRUCK VEHICLE ADAPTER KIT

- 20,000 LBS MAX SUPPORT CAPACITY (10,000 LBS PER ADAPTER)
- ALLOWS FOR WHEELS FREE SERVICE WITH FRAME-ENGAGING LIFTING
- FRAME-ENGAGING 'END' LIFTING FOR FRONT & REAR OF MOST VEHICLES
- REQUIRES TWO MSC-13KB COLUMN OPERATION
- ADJUSTABLE WIDTH PILLAR SUPPORTS
- STANDARD HD SWIVEL / RUBBER CONTACT PADS
- USED IN PAIRS ONLY WITH TWO COLUMN LIFT CONFIGURATION
- WORKS ONLY WITH MSC-13K-B LIFT

MSC-STAND18X

IDEAL, HEAVY-DUTY HIGH-RISE STAND

- ALLI CERTIFIED
- 18,000 LBS MAX SUPPORT CAPACITY
- ADJUSTABLE PILLAR HEIGHT WITH SPRING ASSIST
- LOCKING HEIGHTS 48-5/8" TO 69-7/8"
- EASY STAND POSITIONING WITH SPRING LOADED CASTERS
- FOLDABLE LEG DESIGN PROVIDES ADDITIONAL STORAGE SPACE



MSC-44K-STAND-46

IDEAL, HEAVY-DUTY MID-RISE STAND

- 20 TONS MAX SUPPORT CAPACITY (40,000 LBS)
- QUALITY BUILT PROFESSIONAL SCREW STYLE JACK STAND
- ADJUSTABLE HEIGHTS 26" - 46"
- SWIVEL STYLE PRECISION LIFT SUPPORT WITH LOCKING COLLAR
- EASY TO TURN HANDLE FOR ACCURATE HEIGHT ADJUSTMENT
- WIDE BASE PROVIDES OPTIMAL JACK STABILITY SUPPORT



MSC-FORKSPACER

IDEAL, MSC FORKLIFT SPACER KIT

- ALLI CERTIFIED
- 20,000 LBS MAX SUPPORT CAPACITY (10,000 LBS PER ADAPTER)
- ALLOWS FOR WHEELS FREE SERVICE WITH FRAME-ENGAGING LIFTING
- FRAME-ENGAGING 'SIDE' LIFTING FOR MOST FORKLIFTS
- REQUIRES TWO MSC-18KX COLUMN OPERATION
- SPACERS SECURELY FIT BETWEEN MSC-18KX LIFTING ARMS
- WORKS WITH ANY MSC LIFT

MSC-44K-STAND-26

IDEAL, HEAVY-DUTY LOW-RISE STAND

- 20 TONS MAX SUPPORT CAPACITY (40,000 LBS)
- QUALITY BUILT PROFESSIONAL SCREW STYLE JACK STAND
- ADJUSTABLE HEIGHTS 16" - 26"
- SWIVEL STYLE PRECISION LIFT SUPPORT WITH LOCKING COLLAR
- EASY TO TURN HANDLE FOR ACCURATE HEIGHT ADJUSTMENT
- WIDE BASE PROVIDES OPTIMAL JACK STABILITY SUPPORT



MSC-FL-RAMPSET

IDEAL, MSC FORKLIFT RAMP SET

- 20,000 LBS MAX SUPPORT CAPACITY (10,000 LBS PER RAMP & PLATFORM)
- ALLOWS FORKLIFT TO BE DRIVEN ONTO ELEVATED LIFTING POSITION
- DESIGNED TO WORK IN CONJUNCTION WITH FORKLIFT SPACERS
- WORKS WITH BOTH MSC-18KX & MSC-13K-B LIFTS



MSC-13K-B ACCESSORY

MSC13KB-RMTCNTRL

IDEAL, MSC-13K-B HANDHELD REMOTE CONTROLLER

- WORKS ONLY WITH MSC-13K-B LIFT MODELS
- ABLE TO USE ON ANY MSC-13K-B COLUMNS
- QUICK & SECURE 'SCREW LOCK' PLUG CONNECTIONS
- INCLUDES UP, DOWN & PARK EMERGENCY CONTROL BUTTONS



(MSC-13K-B LIFTS ONLY)



(MSC FORK SPACER & FL RAMP SET SHOWN)

WHEEL BALANCERS

WB-953-B WHEEL BALANCER

- HIGH PERFORMANCE
- SELF-CALIBRATING
- 24" WHEEL
- MANUAL DATA ENTRY
- NO HOOD
- FOUR CONES 1-5/8" - 6-1/16"
- THREE ALU MODES
- OPTIONAL TRUCK KIT AND MOTORCYCLE KIT



WB-953 WHEEL BALANCER

- HIGH PERFORMANCE
- SELF-CALIBRATING
- 24" WHEEL
- MANUAL DATA ENTRY
- FOUR CONES 1-5/8" - 6-1/16"
- THREE ALU MODES
- OPTIONAL TRUCK KIT AND MOTORCYCLE KIT



WB-CB66-VE WHEEL BALANCER

- HIGH PERFORMANCE
- 40MM SHAFT
- SELF-CALIBRATING
- 28" WHEEL
- MANUAL DATA ENTRY
- FOOT BRAKE
- WHEEL ILLUMINATION
- FOUR CONES 1-5/8" - 6-1/4"
- FIVE ALU MODES
- OPTIONAL TRUCK KIT, LUG ADAPTER AND MOTORCYCLE KIT



WB-448 WHEEL BALANCER HEAVY DUTY

- 298 LBS CAPACITY
- 42MM SHAFT
- SELF-CALIBRATING
- 24" WHEEL
- MANUAL DATA ENTRY
- MULTIPLE FLANGES AND CONES
- NO HOOD
- WHEEL LIFT INCLUDED
- BALANCES TRUCKS & CARS



WHEEL BALANCER ACCESSORIES



WB-448-PWL

- WHEEL LIFT FOR USE WITH ALL BALANCERS
- 440LBS. CAPACITY
- AIR OPERATED
- LIFTS TO 17"



WB-B-W-07

- LUG ADAPTER
- FOR USE WB-CB66-VE OR 40MM SHAFT



WB-953-LTCS WB-CB6-LTCS

- LIGHT TRUCK KIT FOR WB-CB66-VE & WB-953 SERIES
- SPACER AND CONE (UP TO 6 1/8")
- FOR USE WITH 3/4T AND SOME 1T TRUCKS



WB-953-TASK WB-CB6-TASK

- DUALY TRUCK KIT FOR WB-953 SERIES (36MM SHAFT) AND WB-CB-6-VE (40MM SHAFT)
- DUAL SIDED CONE (4 3/4" - 6 1/8")
- ALUMINUM SPACER 1 3/4" OFFSET

WHEEL BALANCER SPECIFICATIONS

Wheel Balancer Model	WB-953-B	WB-953	WB-CB66-VE	WB-448
Data Entry	Keypad	Keypad	Keypad	Keypad
Max Wheel Diameter	39"	39"	44"	47"
Rim Width	1.5" - 20"	1.5" - 20"	1.5" - 20"	1.5" - 20"
Rim Diameter	10" - 24"	10" - 24"	10" - 28"	10" - 24"
Wheel Weight Capacity	150 lbs	150 lbs	150 lbs	298 lbs
Accuracy	1 gram	1 gram	1 gram	1 gram
Power	110V - 15 Amp - 1PH	110V - 15 Amp - 1PH	110V - 15 Amp - 1PH	220V - 20 Amp - 1PH
Ship Weight	305 lbs	335 lbs	352 lbs	650 lbs

POWERSPORT BALANCER ACCESSORIES



WB-CB6-MCAK-16

WB-CB66-VE MOTORCYCLE ADAPTOR KIT

- WHEEL CLAMP (14-1/2" - 32" TIRE DIAMETER)
- STANDARD 14MM SHAFT
- CONES UP TO 1-1/8"
- FOR USE WITH WB-CB66-VE



WB-953-ADAPTER-B

WB-953 MOTORCYCLE 'STANDARD' ADAPTOR KIT

- WHEEL CLAMP (14-1/2" - 32" TIRE DIAMETER)
- STANDARD 14MM SHAFT
- CONES UP TO 1-1/8"
- FOR USE WITH WB-953 & WB-1030
- OPTIONAL WB-953-ADAPTER-S



WB-953-ADAPTER-S

WB-943 MOTORCYCLE 'LARGE' SHAFT ADAPTOR KIT

- HEAVY DUTY 19MM SHAFT
- FOR HEAVY WHEELS
- CONES UP TO 1-15/16"



WB-953-HDASY

- HOOD ASSEMBLY FOR WB-953 SERIES

WB-448-HD1

- HOOD ASSEMBLY FOR WB-448

WHEEL WEIGHTS & KITS

WW-BASIC

Basic Wheel Weight Kit

WW-DELUXE

Deluxe Wheel Weight Kit



*Wheel Weights sold as kits or individually

Basic Kit includes one complete set of clip on weights for steel applications and one box of adhesive weights

Deluxe Kit includes one complete set of clip on weights for aluminum application, one complete set of clip on weights for steel application, and one box of adhesive weights

CLIP ON WHEEL WEIGHT FOR ALUMINUM APPLICATION

- WW-A-.25 .25 oz - 50 pieces per box
- WW-A-.50 .50 oz - 50 pieces per box
- WW-A-.75 .75 oz - 50 pieces per box
- WW-A-1 1.0 oz - 25 pieces per box
- WW-A-1.5 1.5 oz - 25 pieces per box
- WW-A-2 2.0 oz - 25 pieces per box
- WW-A-2.5 2.5 oz - 25 pieces per box
- WW-A-3 3.0 oz - 25 pieces per box



CLIP ON WHEEL WEIGHT FOR STEEL APPLICATION

- WW-S-.25 .25 oz - 50 pieces per box
- WW-S-.50 .50 oz - 50 pieces per box
- WW-S-.75 .75 oz - 50 pieces per box
- WW-S-1 1.0 oz - 25 pieces per box
- WW-S-1.5 1.5 oz - 25 pieces per box
- WW-S-2 2.0 oz - 25 pieces per box
- WW-S-2.5 2.5 oz - 25 pieces per box
- WW-S-3 3.0 oz - 25 pieces per box



ADHESIVE WHEEL WEIGHTS

- WW-AD-.25 .25 oz - 50 strips - 12 squares per strip



TIRE CHANGERS

ECONOMY

TC-430

TIRE CHANGER

- TRADITIONAL SWING ARM DESIGN
- FOUR PNEUMATIC CLAMPS
- HAND HELD INFLATION
- BEAD BREAKER
- ELECTRIC TABLE ROTATION
- UP TO 38" TIRE
- UP TO 11" WIDE WHEEL
- NO BEAD SEATER
- OPTIONAL ASSIST ARM, MOTORCYCLE ADAPTER



TC-530

TIRE CHANGER

- TRADITIONAL SWING ARM DESIGN
- FOUR PNEUMATIC CLAMPS
- FOOT OPERATED INFLATION
- BEAD SEATER INTEGRATED INTO CLAMPS
- TOWER ACTS AS AUXILIARY AIR TANK
- ELECTRIC TABLE ROTATION
- UP TO 38" TIRE
- UP TO 12" WIDE WHEEL
- PNEUMATIC BEAD BREAKER
- OPTIONAL MOTORCYCLE ADAPTER



COMMERCIAL

TC-950

TIRE CHANGER

- COMMERCIAL GRADE
- TRADITIONAL SWING ARM DESIGN
- FOUR POWERFUL PNEUMATIC CLAMPS
- FOOT OPERATED INFLATION
- BEAD SEATER INTEGRATED INTO CLAMPS
- TOWER ACTS AS AUXILIARY AIR TANK
- ELECTRIC TABLE ROTATION
- UP TO 47" TIRE
- UP TO 15" WIDE WHEEL
- PNEUMATIC BEAD BREAKER
- OPTIONAL ASSIST ARM, MOTORCYCLE ADAPTER



TC-950-WPA

TIRE CHANGER

- TC-950 WITH ASSIST ARM
- ASSIST ARM SIMPLIFIES CHANGING LOW PRO AND STIFF SIDEWALL TIRES
- OPTIONAL MOTORCYCLE ADAPTER



PROFESSIONAL

TC-1300

TIRE CHANGER

- PROFESSIONAL GRADE
- PNEUMATIC TILT BACK DESIGN
- LEVERLESS DEMOUNT HEAD
- FOUR PNEUMATIC CLAMPS
- BEAD SEATER INTEGRATED INTO CLAMPS
- REAR MOUNT AUXILIARY AIR TANK
- ELECTRIC TABLE ROTATION
- UP TO 41" TIRE
- UP TO 15" WIDE WHEEL
- PNEUMATIC BEAD BREAKER
- MULTI USE RIGHT SIDE ASSIST ARM
- THE MACHINE FOR DIFFICULT TO MOUNT TIRES



HEAVY DUTY

TC-770-T

TIRE CHANGER

- HEAVY DUTY COMMERCIAL GRADE
- POWERFUL ELECTRIC HYDRAULIC OPERATION
- HYDRAULIC SLIDE MOVES WHEEL TO CLAMPS
- FOUR HYDRAULIC CLAMPS
- ARTICULATING HEAD ADJUSTS TO WHEEL HEIGHT
- SIMPLE JOYSTICK OPERATION FOR DEMOUNT HEAD AND CLAMP POSITION
- PEDAL OPERATION FOR WHEEL ROTATION
- 220VAC SINGLE PHASE



POWER SPORT TIRE CHANGERS

TC-400M-B

POWER SPORT TIRE CHANGER

- MOTORCYCLE / ATV TIRE CHANGER
- SWING ARM DESIGN
- ADJUSTABLE CLAMP SEAT FOR EXPANDED RANGE
- FOUR PNEUMATIC CLAMPS
- PLASTIC CLAMPS LIMIT DAMAGE
- ELECTRIC TABLE ROTATION
- HAND HELD INFLATION



TC-MCATVM

MANUAL MOTORCYCLE / ATV TIRE CHANGER

- EXCELLENT FOR ENTHUSIAST AND HOBBYIST
- THREE CLAMP SYSTEM
- INTEGRATED BEAD BREAKER
- CLAMPING RANGE 4" - 21"
- UP TO 11" WIDE TIRE
- ACCOMMODATES TUBED AND TUBELESS TIRES



TIRE CHANGER ACCESSORIES



TC-400M-B

TC-430

TC-400M-B-PL230

TC-400M-B ASSIST ARM ASSEMBLY

- TOWER MOUNTED ASSIST ARM
- SIMPLIFIES MOUNTING OF LOW PROFILE / STIFF SIDEWALL TIRES
- LIMITS DAMAGE TO EXPENSIVE WHEELS
- FOR USE WITH TC-400M-B & TC-430



TC-950-WPA-1

TC-950 ASSIST ARM ASSEMBLY

- LEFT SIDE MOUNT ASSIST ARM
- SIMPLIFIES CHANGING OF LOW PROFILE / STIFF SIDEWALL TIRES
- LIMITS DAMAGE TO EXPENSIVE WHEELS
- FOR USE WITH TC-950

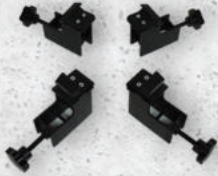

TC-MC-AN

TIRE CHANGER MOTORCYCLE / ATV ADAPTER KIT

- MOTORCYCLE / ATV CLAMP ADAPTERS
- ADAPTS TIRE CHANGER CLAMPS TO CHANGE MOTORCYCLE & ATV WHEELS
- CHANGE TIRES WITHOUT REMOVING BRAKE DISCS OR DRIVE COMPONENTS
- FOR USE WITH TC-430, TC-530 & TC-950



TS-250

PEDESTAL TIRE SPREADER

- MANUAL / VERTICAL OPERATION
- 360-DEGREE SWIVEL TOP WITH DUAL SUPPORT ROLLERS
- ADJUSTABLE TIRE WIDTH RANGE 5-11/16" TO 13-3/4"
- 36" CONVENIENT PEDESTAL PLATFORM HEIGHT



TC-ATSB-1

PORTABLE TIRE SPREADER

- MANUAL / VERTICAL OPERATION
- TIRE WIDTH RANGE 5-3/4" TO 10-3/4"
- LARGE 14" MOUNTING BASE
- DESIGNED FOR USE WITH MOST WHEEL CLAMP TIRE CHANGERS

TIRE CHANGER SPECIFICATIONS

Tire Changer Model	TC-430	TC-530	TC-950	TC-950-WPA
Max Wheel Diameter	38"	38"	47"	47"
Wheel Width	3" - 11"	3" - 12"	3" - 14.5"	3" - 14.5"
Inside - Rim Clamp Range	12" - 21"	12" - 23"	15" - 28"	15" - 28"
Outside - Rim Clamp Range	10" - 18"	10" - 20"	13" - 24"	13" - 24"
Power	110V - 15 Amp - 1PH	110V - 15 Amp - 1PH	110V - 15 Amp - 1PH	110V - 15 Amp - 1PH
Working Pressure	125 psi	125 psi	125 psi	125 psi
Ship Weight	460 lbs	560 lbs	640 lbs	880 lbs

Tire Changer Model	TC-1300	TC-770-T	TC-400M-B	TC-MCATVM
Max Wheel Diameter	41"	64.5"	37"	4" - 21"
Wheel Width	3" - 15"	31.5"	10"	11"
Inside - Rim Clamp Range	13" - 26"	14" - 26"	N/A	NA
Outside - Rim Clamp Range	11" - 24"	N/A	6" - 24"	3" - 12.5"
Power	110V - 15 Amp - 1PH	220V - 20 Amp - 1PH	110V - 15 Amp - 1PH	Manual
Working Pressure	125 psi	N/A	125 psi	NA
Ship Weight	975 lbs	1,690 lbs	470 lbs	73 lbs

SHOP TABLES & WORK BENCHES



PTDT-PW-1000

IDEAL, PREMIUM TEAR DOWN TABLE
W/ RETRACTABLE 3.5G PARTS WASHER

- 1,000 LBS CAPACITY
- HEAVY DUTY STEEL CONSTRUCTION
- EASY BOLT TOGETHER ASSEMBLY
- INTEGRATED TABLE DRAIN & CATCH BASIN
- LOCKABLE STORAGE DRAWER
- LARGE 46.8"W X 31.5"L TABLETOP AREA
- 4" SWIVEL POLY CASTERS (2 LOCKING)
- DURABLE POWDER COAT FINISH
- AVAILABLE BLACK OR BLUE



PTDT-1000

IDEAL, PREMIUM
TEAR DOWN TABLE

- 1,000 LBS CAPACITY
- HEAVY DUTY STEEL CONSTRUCTION
- EASY BOLT TOGETHER ASSEMBLY
- INTEGRATED TABLE DRAIN & CATCH BASIN
- LOCKABLE STORAGE DRAWER
- LARGE 46.8"W X 31.5"L TABLETOP AREA
- 4" SWIVEL POLY CASTERS (2 LOCKING)
- DURABLE POWDER COAT FINISH
- AVAILABLE BLACK OR BLUE



PWB-TC-1600

IDEAL, PREMIUM WORK
BENCH & TOOL CABINET

- 1,600 LBS CAPACITY
- HEAVY DUTY STEEL CONSTRUCTION
- EASY BOLT TOGETHER ASSEMBLY
- LARGE 59.5" X 27.5" WORK BENCH AREA
- FULLY ADJUSTABLE LEVELING LEG STANDS
- 2" RETAINING FENCE ON THREE SIDES
- DURABLE POWDER COAT FINISH
- AVAILABLE BLACK OR BLUE



PWB-1600

IDEAL, PREMIUM WORK BENCH

- 1,600 LBS CAPACITY
- HEAVY DUTY STEEL CONSTRUCTION
- EASY BOLT TOGETHER ASSEMBLY
- LARGE 59.5" X 27.5" WORK BENCH AREA
- FULLY ADJUSTABLE LEVELING LEG STANDS
- 2" RETAINING FENCE ON THREE SIDES
- DURABLE POWDER COAT FINISH
- AVAILABLE BLACK OR BLUE

TRANSMISSION JACK, STANDS & OIL DRAINS



2158-TJ TRANSMISSION JACK

- 1,100LBS. CAPACITY
- SINGLE STAGE CYLINDER
- FOOT PUMP
- MANUAL HAND RELEASE
- ADJUSTABLE SADDLE
- 45" - 71" HEIGHT



3320-STAND UNDER HOIST STAND

- 3/4 TON SINGLE POLE JACK STAND
- "V" SADDLE FOR EXHAUST OR DRIVE SHAFT WORK
- FOOT PEDAL FOR HANDS FREE HELP
- 53 1/2" - 80" HEIGHT
- DESIGNED TO SUPPORT VEHICLE COMPONENTS

(Not designed for vehicle support)



3315-STAND UNDER HOIST STAND

- 2 TON TRIPOD JACK STAND
- STEEL SADDLE WITH RUBBER PAD
- DESIGNED FOR VEHICLE SUPPORT (USED IN PAIRS)
- 55" - 85 1/2" HEIGHT



8G-DRAIN 8 GALLON

- 8 GALLON PLASTIC TANK
- 18" PLASTIC FUNNEL
- MANUAL POUR EVACUATION
- 48" - 71" HEIGHT
- FOUR 3.5" CASTERS



18G-DRAIN 18 GALLON

- 18 GALLON PLASTIC TANK
- 18" PLASTIC FUNNEL
- MANUAL HAND PUMP EVACUATION
- 48" - 71" HEIGHT
- FOUR 3.5" CASTERS



24G-SE-DRAIN 24 GALLON

- 24 GALLON STEEL TANK
- 17" FUNNEL
- PNEUMATIC SELF EVACUATION
- 50" - 73" HEIGHT
- 7' EVACUATION HOSE
- STORAGE TRAY FOR DRAIN PLUG, FILTER & GASKET
- PORTABLE & FIXED CASTERS

LIFT TABLES NEW



LT-EV2500AH-X

NEW

IDEAL EV 2500AH-X LIFT TABLE - EV BATTERY PLATFORM / AIR HYDRAULIC OP

- 2,500 LBS CAPACITY
- PROVIDES SAFE & EFFICIENT METHOD TO REMOVE & INSTALL EV BATTERY PACKS
- INNOVATIVE, HIGH QUALITY PORTABLE SCISSOR LIFT DESIGN
- FULL OPERATIONAL AIR SYSTEM HAND CONTROLS FOR LIFTING, LOCKING & LOWERING
- AIR / HYDRAULIC OPERATION (90 TO 125 PSI)
- INTEGRATED AIR GAUGE W/ FILTER, LUBRICATOR & REGULATOR
- INSULATED, MULTI-DIRECTIONAL SLIDING EV PLATFORM W/ ADJUSTABLE LATCH CLAMPS
- HD JACK SCREWS FOR PRECISION 'TILT & HEIGHT' EV PLATFORM ADJUSTMENTS
- DOUBLE SCISSOR DESIGN W/ SINGLE HD HYDRAULIC CYLINDER
- INTEGRATED UTILITY / TOOL TRAY
- DURABLE 'DIRECTIONAL & LOCKING' POLY SWIVEL CASTERS
- EV PLATFORM SIZE 31.5"W X 59"L
- 3EA LOCKING HEIGHT POSITIONS
- MAX LIFT HEIGHT 72.6"
- MIN LIFT HEIGHT 35.4"
- OVERALL SIZE 74.6"L X 35.4"W
- 72S RISE & 33S LOWER TIME
- INCLUDES 4EA RUBBER BLOCKS (6.4"L X 4"W X 1.45"H)



LT-PT2500AH-X

NEW

IDEAL PT 2500AH-X LIFT TABLE - POWERTRAIN PLATFORM / AIR HYDRAULIC OP

- 2,500 LBS CAPACITY
- PROVIDES SAFE & EFFICIENT METHOD TO REMOVE & INSTALL HEAVY POWERTRAIN COMPONENTS, SUCH AS TRANSMISSIONS, ENGINES OR AXLES
- INNOVATIVE, HIGH QUALITY PORTABLE SCISSOR LIFT DESIGN
- FULL OPERATION AIR SYSTEM HAND CONTROLS FOR LIFTING, LOCKING & LOWERING
- AIR / HYDRAULIC OPERATION (90 TO 125 PSI)
- INTEGRATED AIR GAUGE W/ FILTER, LUBRICATOR & REGULATOR
- HD TELESCOPING PT PLATFORM W/ 5.2" ADJUSTMENT LENGTH & LOCKING KNOB SCREWS
- HD JACK SCREWS FOR PRECISION 'TILT & HEIGHT' PT PLATFORM ADJUSTMENTS
- DOUBLE SCISSOR DESIGN W/ SINGLE HD HYDRAULIC CYLINDER
- INTEGRATED UTILITY / TOOL TRAY
- DURABLE 'DIRECTIONAL & LOCKING' POLY SWIVEL CASTERS
- PT PLATFORM SIZE 23.6"W X 31.5 - 36.7"L
- 3EA LOCKING HEIGHT POSITIONS
- MAX LIFT HEIGHT 72"
- MIN LIFT HEIGHT 35"
- OVERALL SIZE 71.25"L X 33.5"W
- 72S RISE & 33S LOWER TIME
- INCLUDES 4EA TIE-DOWN RING EYELETS & HD RATCHET STRAP



LT-EV3300DC-X

NEW

IDEAL EV 3300DC-X LIFT TABLE - EV BATTERY PLATFORM / DC BATTERY OP

- 3,300 LBS CAPACITY
- PROVIDES SAFE & EFFICIENT METHOD TO REMOVE & INSTALL EV BATTERY PACKS
- INNOVATIVE, HIGH QUALITY PORTABLE SCISSOR LIFT DESIGN
- FULL ELECTRICAL OPERATIONAL W/ MAGNETIC HAND PENDANT & CONTROL PANEL BUTTONS FOR EASE OF LIFTING, LOCKING & LOWERING
- 12VDC BATTERY OPERATION W/ INTEGRATED 110V BATTERY CHARGER
- INSULATED, MULTI-DIRECTIONAL SLIDING EV PLATFORM W/ ADJUSTABLE LATCH CLAMPS
- HD JACK SCREWS FOR PRECISION 'TILT & HEIGHT' EV PLATFORM ADJUSTMENTS
- DOUBLE SCISSOR DESIGN W/ DUAL HD HYDRAULIC CYLINDERS
- INTEGRATED UTILITY / TOOL TRAY
- PORTABILITY EASE UTILIZING PALLET JACK OPERATION W/ 'DIRECTIONAL & LOCKING' POLY SWIVEL CASTERS
- EV PLATFORM SIZE 31.5"W X 59"L
- 3EA LOCKING HEIGHT POSITIONS
- MAX LIFT HEIGHT 72.6"
- MIN LIFT HEIGHT 35.4"
- OVERALL SIZE 67.3"L X 35.4"W
- 20S RISE & 22S LOWER TIME
- INCLUDES 4EA RUBBER BLOCKS (6.4"L X 4"W X 1.45"H)
- OPTIONAL 12VDC LED SPOT LIGHT W/ MAGNETIC BASE & PLUG (MSC-LEDLAMP)



LT-PT3300DC-X

NEW

IDEAL PT 3300DC-X LIFT TABLE - POWERTRAIN PLATFORM / DC BATTERY OP

- 3,300 LBS CAPACITY
- PROVIDES SAFE & EFFICIENT METHOD TO REMOVE & INSTALL HEAVY POWERTRAIN COMPONENTS
- SUCH AS TRANSMISSIONS, ENGINES OR AXLES
- INNOVATIVE, HIGH QUALITY PORTABLE SCISSOR LIFT DESIGN
- FULL ELECTRICAL OPERATIONAL W/ MAGNETIC HAND PENDANT & CONTROL PANEL BUTTONS FOR EASE OF LIFTING, LOCKING & LOWERING
- 12VDC BATTERY OPERATION W/ INTEGRATED 110V BATTERY CHARGER
- HD TELESCOPING PT PLATFORM W/ 5.2" ADJUSTMENT LENGTH & LOCKING KNOB SCREWS
- HD JACK SCREWS FOR PRECISION 'TILT & HEIGHT' PT PLATFORM ADJUSTMENTS
- DOUBLE SCISSOR DESIGN W/ DUAL HD HYDRAULIC CYLINDERS
- INTEGRATED UTILITY / TOOL TRAY
- PORTABILITY EASE UTILIZING PALLET JACK OPERATION W/ 'DIRECTIONAL & LOCKING' POLY SWIVEL CASTERS
- PT PLATFORM SIZE 23.6"W X 31.5 - 36.7"L
- 3EA LOCKING HEIGHT POSITIONS
- MAX LIFT HEIGHT 72"
- MIN LIFT HEIGHT 35"
- OVERALL SIZE 65.2"L X 33.5"W
- 30S RISE & LOWER TIME
- INCLUDES 4EA TIE-DOWN RING EYELETS & HD RATCHET STRAP
- OPTIONAL 12VDC LED SPOT LIGHT W/ MAGNETIC BASE & PLUG (MSC-LEDLAMP)



IDEAL PRO-SERIES POWER SPORTS LIFTS



M-2200IEH-XR

ELECTRIC / HYDRAULIC MOTORCYCLE LIFT BENCH

- EXCLUSIVE - 'FULL WIDTH' RETRACTABLE RAMP SYSTEM
- 2,200 LBS. CAPACITY
- 47" RISE HEIGHT
- 31.5" X 88.6" PLATFORM SIZE
- HAND HELD REMOTE CONTROL PENDANT
- 110V INTEGRATED ELECTRIC / HYDRAULIC POWER UNIT
- MAGNETIC LOCK RELEASE
- SIX LOCKING POSITIONS
- REAR DROP DOWN SERVICE PANEL
- STABILIZER BAR
- WHEEL STOP
- TIE-DOWN ANCHOR EYE BOLTS
- PLATFORM DESIGNED TO MOUNT OPTIONAL M-VISE OR M-CHOCK
- AVAILABLE BLACK OR **BLUE**

A-2200IEH-XR

ELECTRIC / HYDRAULIC ATV LIFT BENCH

- EXCLUSIVE - 'FULL WIDTH' RETRACTABLE RAMP SYSTEM
- 2,200 LBS. CAPACITY
- 47" RISE HEIGHT
- 50" X 88.6" PLATFORM SIZE
- HAND HELD REMOTE CONTROL PENDANT
- 110V INTEGRATED ELECTRIC / HYDRAULIC POWER UNIT
- MAGNETIC LOCK RELEASE
- SIX LOCKING POSITIONS
- REAR DROP DOWN SERVICE PANEL
- STABILIZER BAR
- WHEEL STOPS
- TIE-DOWN ANCHOR EYE BOLTS
- PLATFORM DESIGNED TO MOUNT OPTIONAL M-VISE OR M-CHOCK
- AVAILABLE BLACK OR **BLUE**



M-2200IEH-XR + TRIKEKIT-2200IEH-XR

ELECTRIC / HYDRAULIC TRIKE LIFT BENCH

- EXCLUSIVE - 'FULL WIDTH' RETRACTABLE RAMP SYSTEM
- 2,200 LBS. CAPACITY
- 47" RISE HEIGHT
- 62.2" X 110.2" PLATFORM SIZE (W/ 21.6" FRONT EXTENSION)
- HAND HELD REMOTE CONTROL PENDANT
- 110V INTEGRATED ELECTRIC / HYDRAULIC POWER UNIT
- MAGNETIC LOCK RELEASE
- SIX LOCKING POSITIONS
- REAR DROP DOWN SERVICE PANEL
- STABILIZER BAR
- WHEEL STOP
- TIE-DOWN ANCHOR EYE BOLTS
- PLATFORM DESIGNED TO MOUNT OPTIONAL M-VISE OR M-CHOCK
- AVAILABLE **BLACK** OR **BLUE**

U-2200IEH-XR

ELECTRIC / HYDRAULIC UTV LIFT BENCH

- EXCLUSIVE - 'FULL WIDTH' RETRACTABLE RAMP SYSTEM
- EXCLUSIVE - SIDE EXTENSIONS W/ CENTER DROP PANELS 2,200 LBS. CAPACITY
- 47" RISE HEIGHT
- 65" X 88.6" PLATFORM SIZE
- HAND HELD REMOTE CONTROL PENDANT
- 110V INTEGRATED ELECTRIC / HYDRAULIC POWER UNIT
- MAGNETIC LOCK RELEASE
- SIX LOCKING POSITIONS
- REAR DROP DOWN SERVICE PANEL
- STABILIZER BAR & WHEEL STOPS
- TIE-DOWN ANCHOR EYE BOLTS
- PLATFORM DESIGNED TO MOUNT OPTIONAL M-VISE OR M-CHOCK
- AVAILABLE **BLACK** OR **BLUE**

PRO-SERIES POWER SPORT LIFT ACCESSORIES

DLYWHLKIT-2200IEH

- DOLLY & WHEEL KIT**
- MAKES 2200 SERIES PORTABLE
 - DOLLY KIT FOR 2200IEH SERIES
 - INCLUDES DOLLY & NOSE WHEEL
 - AVAILABLE **BLACK** OR **BLUE**



RMPEXT-2200IEH-XR

- 2200IEH-XR RAMP EXTENSION**
- REDUCES RAMP ANGLE FOR LOW PROFILE MOTORCYCLES
 - 35" L X 16" W RAMP SIZE
 - DESIGNED TO WORK WITH 2200IEH-XR RETRACTABLE RAMP
 - AVAILABLE **BLACK** OR **BLUE**

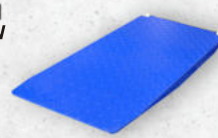

FRTEXT-2200IEH

- FRONT EXT. PANEL**
- FRONT EXTENSION FOR 2200 SERIES
 - INCREASES TABLE LENGTH TO 110-1/4"
 - AVAILABLE **BLACK** OR **BLUE**

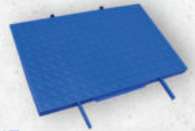

BLACK
Now Available!!

ATVKIT-2200IEH-XR

- ATV KIT FOR M-2200IEH-XR**
- INCREASES TABLE WIDTH TO 50"
 - AVAILABLE **BLACK** OR **BLUE**
 - (ALREADY INCLUDED W/ A-2200IEH-XR)



UTVKIT-2200IEH-XR

- UTV KIT FOR M-2200IEH-XR**
- INCREASES TABLE WIDTH TO 65"
 - AVAILABLE **BLACK** OR **BLUE**
 - (ALREADY INCLUDED W/ U-2200IEH-XR)



PRO-SERIES POWER SPORT LIFT SPECIFICATIONS

Lift Model	M-2200IEH-XR	A-2200IEH-XR	M-2200IEH-XR + TRIKEKIT-2200IEH-XR	U-2200IEH-XR	UF-2200EH-X
Capacity	2,200 lbs	2,200 lbs	2,200 lbs	2,200 lbs	2,200 lbs
Min. Height	7"	7"	7"	7"	4-3/4"
Max Lifting Height	47-1/4"	47-1/4"	47-1/4"	47-1/4"	43"
Overall Length w/ Ramp	116-1/2"	116-1/2"	138-1/4"	116-1/2"	67" - 88-7/8"
Overall Width	58"	58"	62-1/4"	65"	24"
Platform Size (L x W)	88-5/8" x 31.5"	88-5/8" x 50"	88-5/8" x 62-1/4"	88-5/8" x 65"	67" x 24"
Lifting Time	30S	30S	30S	30S	25S
Lowering Time	30S	30S	30S	30S	25S
Power	110V, 60Hz, 1 PH-18A	110V, 60Hz, 1 PH-18A	110V, 60Hz, 1 PH-18A	110V, 60Hz, 1 PH-18A	110V, 60Hz, 1 PH-18A
Ship Weight	704 lbs	880 lbs	1,015 lbs	970 lbs	740 lbs

PRO-SERIES POWER SPORT UTV FRAME LIFT



BLACK
Now Available!!



BLACK
Now Available!!



UF-2500EH-X

ELECTRIC / HYDRAULIC UTV FRAME LIFT

- 2,500 LBS. CAPACITY
- 43" RISE HEIGHT & 4.75" MIN. HEIGHT
- 24" X 88.9" PLATFORM SIZE
- LOAD BEARING HINGED RAMPS
- PORTABLE OR MOUNTED PEDESTAL CONTROLS
- 110V INTEGRATED ELECTRIC / HYDRAULIC POWER UNIT
- MAGNETIC LOCK RELEASE
- 3ea LOCKING POSITIONS
- RUBBER CONTACT LIFT PADS - 4.75" X 6.5" (4EA)
- AVAILABLE **BLACK** OR **BLUE**

WHLSTDKIT-UF2500EH-X

IDEAL, UF-2500EH-X UTV / ATV WHEEL STAND KIT

- DESIGNED FOR USE WITH UF-2500EH-X FRAME LIFT
- PROVIDES ADDITIONAL UNDERCARRIAGE SERVICE ABILITY
- SUPPORTS LARGEST UTV & ATV POWER SPORT VEHICLES
- EXCLUSIVE 'SPRING CASTERS' FOR MOBILITY EASE TO LIFT
- 625 LBS. CAPACITY PER STAND / 2,500 LBS. TOTAL CAPACITY
- ADJUSTABLE HEIGHTS - 24.4" TO 42"
- FIVE LOCKING HEIGHT POSITIONS
- INCLUDES 4EA WHEEL STANDS
- ALL HARDWARE INCLUDED
- AVAILABLE **BLACK** OR **BLUE**



POWER SPORT LIFTS

M-1000C PNEUMATIC MOTORCYCLE LIFT

- 1,000LBS CAPACITY
- 30" LIFT HEIGHT
- 84" X 24" TABLE
- AIR POWERED
- REAR DROP OUT PANEL
- (OPTIONS: M-VISE, M-JACK, M-SIDEEXT, M-FRONTTEXT)



(SHOWN WITH OPTIONAL VISE)



(SHOWN WITH OPTIONAL VISE, M-FRONTTEXT, & M-SIDEEXT)

BLACK
Now Available!!

M-1500C-HR HIGH RISE MOTORCYCLE LIFT

UPDATED

- 1,500 LBS CAPACITY
- IDEAL FOR MOTORCYCLES, ATVS & SNOWMOBILES
- 38-1/2" LIFTING HEIGHT
- 88-1/2" L X 50" W PLATFORM W/ SIDE EXTENSIONS
- 88-1/2" L X 31-1/2" W PLATFORM
- HEAVY-DUTY DIAMOND PLATE PLATFORM
- PROTECTIVE METAL CASE FOR AIR HYDRAULIC PUMP
- AIR / HYDRAULIC OPERATION
- MANUAL MAGNETIC LOCK OPERATION
- MOTORCYCLE VISE, SIDE EXTENSIONS &
- SERVICE SUPPORT POLES INCLUDED

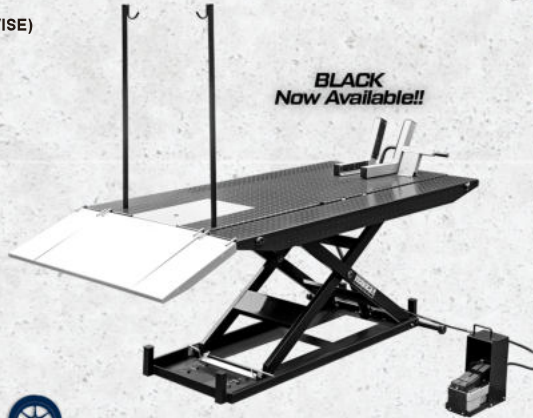

BLACK
Now Available!!

DLYWHLKIT-2200IEH DOLLY & WHEEL KIT

NEW

- INCLUDES BOTH NOSE DOLLY & WHEEL KIT
- PROVIDES CONVENIENT LIFT PORTABILITY
- ADJUSTABLE HEIGHT POLY WHEELS
- ALL HARDWARE INCLUDED
- ALSO AVAILABLE IN BLUE!



POWER SPORT ACCESSORIES

M-VISE CYCLE VISE

- ADJUSTABLE VISE
- USE PRIOR TO STRAPPING
- FOR USE WITH M-1000C AND 2200 SERIES
- MOUNTS TO MOST MOTORCYCLE LIFTS (DRILLING REQ.)



M-CHOCK CYCLE CHOCK

- HANDS FREE ROLL IN CHOCK
- CAPTURES TIRE PRIOR TO STRAPPING
- FOR USE WITH 2200 SERIES
- MOUNTS TO MOST MOTORCYCLE LIFTS (DRILLING REQ.)



M-JACK CYCLE JACK

- 1,100LBS CAPACITY
- MIN. HEIGHT 3 3/4"
- MAX. HEIGHT 15 1/4"
- INCLUDES 2 ADJUSTABLE FRAME CRADLES
- INCLUDES PLATFORM 17 23/32" X 5 29/32"



M-SIDEEXT

- M-1000C SIDE EXTENSION KIT
- INCREASES TABLE WIDTH TO 48"



M-FRONTTEXT

- M-1000C FRONT EXTENSION
- INCREASES TABLE LENGTH TO 97"



DMCS-1000

DELUXE CYCLE STAND

- 1,000LBS
- HAND OPERATED STAND
- RAISES FRONT OR REAR WHEEL
- FOR SERVICE OR DETAILING



POWER SPORT LIFT SPECIFICATIONS

Lift Model	M-1000C	M-1000C + M-SIDEEXT	M-1500C-HR
Capacity	1,000 lbs	1,000 lbs	1,500 lbs
Min. Height	7"	7"	6-3/4"
Max Lifting Height	30"	30"	38-1/2"
Overall Length w/ Ramp	108"	108"	109-1/2"
Overall Width	47"	48"	50"
Platform Size (L x W)	84" x 24"	84" x 48"	88-1/2" x 50"
Power	Air (90-100 PSI)	Air (90-100 PSI)	Air (90-125 PSI)
Ship Weight	395 lbs	540 lbs	765 lbs

IDEAL POWER SPORT WHEEL SERVICE

TC-400M-B-IDEAL

PS TIRE CHANGER

- 6" - 24" CLAMPING RANGE
- SWING ARM DESIGN
- ADJUSTABLE CLAMP SEAT FOR EXPANDED RANGE
- FOUR PNEUMATIC CLAMPS
- PLASTIC CLAMPS LIMIT DAMAGE
- ELECTRIC TABLE ROTATION
- HAND HELD INFLATION



TC-400M-B-PL230-K

PS TIRE CHANGER ASSIST ARM

- TC-400M-B-IDEAL WITH ASSIST ARM
- ASSIST ARM SIMPLIFIES CHANGING LOW PRO AND STIFF SIDEWALL TIRES
- 6" - 24" CLAMPING RANGE
- SWING ARM DESIGN
- ADJUSTABLE CLAMP SEAT FOR EXPANDED RANGE
- FOUR PNEUMATIC CLAMPS
- PLASTIC CLAMPS LIMIT DAMAGE
- ELECTRIC TABLE ROTATION
- HAND HELD INFLATION



WB-953-B-MCAB-K

MOTORCYCLE WHEEL BALANCER

- INCLUDES MOTORCYCLE KIT
- WHEEL CLAMP
- 14MM SHAFT CONES UP TO 1-1/8"
- SELF-CALIBRATING
- 24" WHEEL
- MANUAL DATA ENTRY
- NO HOOD
- INCLUDES AUTOMOTIVE LIGHT VEHICLE COMPONENTS
- 4 CONES
- 36MM SHAFT
- QUICK NUT



WB-953-B-MCAB-K-BLK

MOTORCYCLE WHEEL BALANCER

- INCLUDES MOTORCYCLE KIT
- WHEEL CLAMP
- 14MM SHAFT CONES UP TO 1-1/8"
- SELF-CALIBRATING
- 24" WHEEL
- MANUAL DATA ENTRY
- NO HOOD
- INCLUDES AUTOMOTIVE LIGHT VEHICLE COMPONENTS
- 4 CONES
- 36MM SHAFT
- QUICK NUT



POWER SPORT WHEEL SERVICE SPECIFICATIONS

Tire Changer Model	TC-400M-B-IDEAL	TC-400M-B-PL230-K
Max Wheel Diameter	37"	37"
Max Wheel Width	10"	10"
Outside - Rim Clamp Range	6" - 24"	6" - 24"
Power Supply	110V - 15 Amp - 1PH	110V - 15 Amp - 1PH
Bead Breaker Force	5,500 lbs	5,500 lbs
Working Pressure	125 psi	125 psi
Ship Weight	470 lbs	530 lbs

Wheel Balancer Model	WB-953-B-MCAB-K	WB-953-B-MCAB-K
Data Entry	Keypad	Keypad
Max Tire Diameter (Motorcycle)	14 1/2" - 32"	14 1/2" - 32"
Max Tire Diameter (Truck/Auto)	39"	39"
Rim Width	1.5" - 20"	1.5" - 20"
Rim Diameter	10" - 24"	10" - 24"
Wheel Weight Capacity	150 lbs	150 lbs
Accuracy	1 gram	1 gram
Power	110V - 15 Amp - 1PH	110V - 15 Amp - 1PH
Ship Weight	305 lbs	305 lbs

CAR ROTATOR & BODY CARTS



CR-3000

CAR ROTATOR

- 3,000LBS CAPACITY CAR ROTISSERIE
- 360 DEGREE ROTATION WITH 12 LOCKING POSITIONS
- TUBULAR STEEL CONSTRUCTION
- HEAVY DUTY BALANCING SYSTEM
- ADJUSTABLE HEIGHT 17 3/4" TO 45 1/4" FROM MOUNTING ARMS TO FLOOR
- FOUR 16" MOUNTING ARMS THAT CAN BE USED FOR DIRECT MOUNTING OR USE OF OPTIONAL MOUNTING ACCESSORIES
- TELESCOPING BAR ALLOWS ADJUSTMENT UP TO 21' 6"
- 2 - 6,000LB CAPACITY JACKS ADJUST WORKING HEIGHT
- SIX PHENOLIC RESIN CASTERS
- DURABLE POWDER COAT FINISH



UPDATED

CR-3000-ATWK

CR-3000 ALL TERRAIN WHEEL KIT

- EASILY TRANSPORT CR-3000 OVER ROUGH SURFACES
- 2,000 LB. CAPACITY
- QUICK & SIMPLE MOUNTING
- DURABLE 'FLAT-FREE' RUBBER WHEELS
- (2) SWIVEL & (2) RIGID CASTERS
- HEAVY DUTY CONSTRUCTION
- POWDER-COAT FINISH

'OPTIONAL' BRACKET ACCESSORIES



CR-3000-UDB
UNIVERSAL DOOR BARS



CR-3000-VALBKT
VALENCE BRACKETS



CR-3000-UNIBKT
UNI-BODY BRACKETS



CR-3000-LSB
LEAF SPRING BRACKETS



CR-3000-MBELSB
MOPAR E BODY LEAF
SPRING BRACKETS



CR-3000-MFB
MOPAR FRONT
BRACKETS

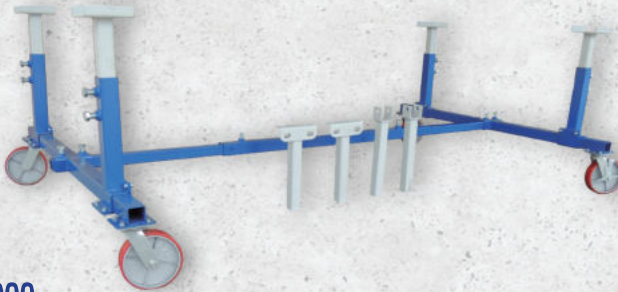

BCA-3000

BODY CART ADJUSTABLE

- 3,000 LBS CAPACITY
- HEAVY DUTY TUBULAR STEEL CONSTRUCTION
- UNIVERSAL DESIGN
- ADJUSTABLE LENGTH, WIDTH & ADAPTOR HEIGHT
- 8" X 2" HD POLY CASTERS (2EA LOCKABLE)
- DURABLE POWDER COAT FINISH
- INCLUDES: (4EA) STRADDLE PAD, BOLT-DOWN & LEAF SPRING ADAPTORS SETS



BCS-3000

BODY CART STANDARD

- 3,000 LBS CAPACITY
- HEAVY DUTY TUBULAR STEEL CONSTRUCTION
- UNIVERSAL DESIGN
- ADJUSTABLE LENGTH & WIDTH
- 8" X 2" HD POLY CASTERS (2EA LOCKABLE)
- DURABLE POWDER COAT FINISH
- INCLUDES: (4EA) 'FIXED HEIGHT' STRADDLE PADSTS

AUTOBODY SPECIFICATIONS

Car Rotisserie	CR-3000
Capacity	3,000 lbs
Width Overall	58-7/8"
Height Overall	77-1/8"
Length Overall	258-1/4"
Lifting Height	17-3/4" - 45-1/4"
Ship Weight	410 lbs

Body Carts	BCS-3000	BCA-3000
Capacity	3,000 lbs	3,000 lbs
Adj. Width	38" - 65"	Up to 60"
Adj. Height	22"	28" - 38"
Adj. Length	38" - 65"	Up to 132"
Ship Weight	188 lbs	289 lbs

FRAME RACKS



FR-77T-18
FRAME RACK MACHINE
TUBULAR DECK - 18' L

FR-77-20
FRAME RACK MACHINE
STEEL PLATE DECK - 20' L

FR-77T-20
FRAME RACK MACHINE
TUBULAR DECK - 20' L

- DURABLE, HEAVY DUTY STEEL DECK CONSTRUCTION
- TILT DECK OPERATION WITH 7,700LBS. CAPACITY WITH DRIVE ON RAMP
- UNIVERSAL ANCHORING SYSTEM WITH ADJUSTABLE HEIGHT PINCH WELD ASSEMBLIES
- TWO - 10 TON PULLING TOWERS WITH TELESCOPING HEADS
- ADJUSTABLE TOWER COLLARS
- OVERHEAD BOOM PULL TOWER EXTENSION
- QUICK DISCONNECT HYDRAULIC FITTINGS
- TWO - 10' PULLING CHAINS WITH HOOKS
- TWO - HIGH QUALITY AIR/HYDRAULIC PUMPS WITH PRESSURE GAUGES
- UNIVERSAL WHEEL STAND AND DEAD VEHICLE DOLLY
- POWDER COAT FINISH

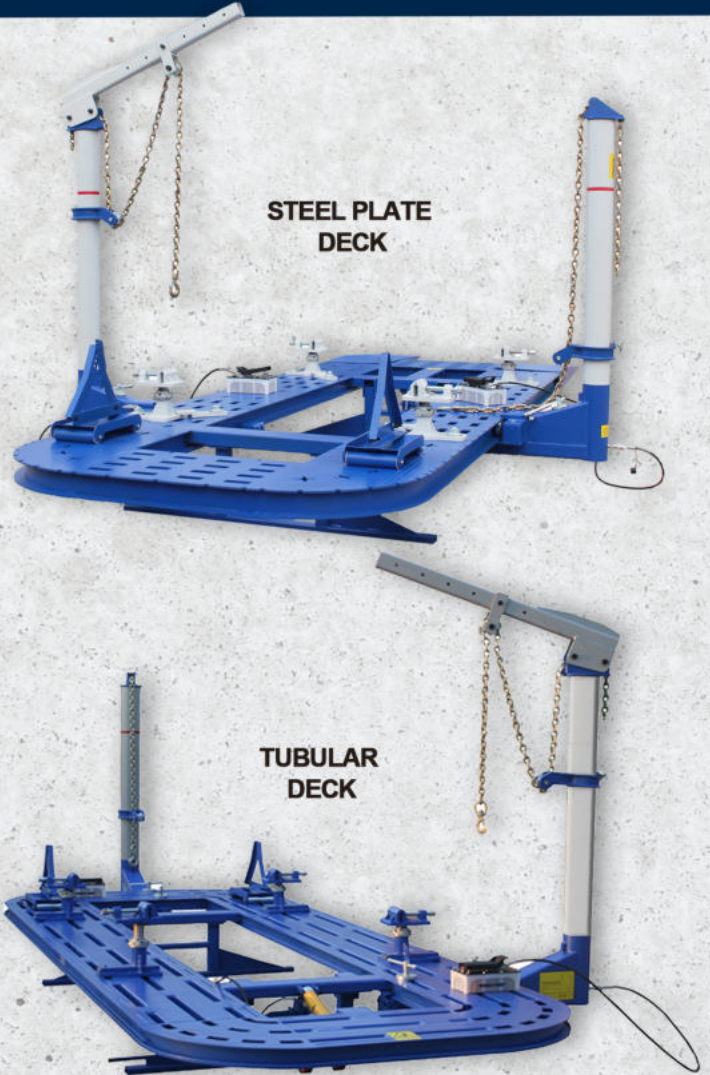

FRAME RACK ACCESSORIES



FR-77-TBK25
25 PIECE FRAME RACK
TOOL BOARD & CLAMP KIT

FRAME RACK TOOL BOARD KITS

THE IDEAL FRAME RACK TOOL KIT CONTAINS ALL OF THE NECESSARY CLAMPS, FIXTURES AND CHAIN TO GRIP, PULL AND HOLD DURING A TYPICAL STRAIGHTENING PROCEDURE. THE TOOL KIT COMES WITH A PORTABLE STORAGE BOARD CONSTRUCTED OF HEAVY GAUGE METAL WITH HOOKS AND SHELVES TO CONVENIENTLY ORGANIZE THE FRAME RACK TOOLS.



FR-BAGJACK AIR BAG JACK

- 4,400 LBS CAPACITY
- LIFTS MOST PASSENGER VEHICLES AND LIGHT TRUCKS
- LOW PROFILE DESIGN
- SIMPLE CONTROLS
- COMPRESSED AIR OPERATION(100PSI)
- INTERNAL TELESCOPING STABILIZATION SLEEVE
- PRESSURE RELIEF VALVE TO ELIMINATE OVER INFLATION

FR-EWINCH ELECTRIC WINCH

- 3,500 LBS CAPACITY
- HEAVY DUTY MARINE GRADE
- HAND HELD REMOTE
- BASE ANCHOR BRACKET
- HAND CRANK
- 12 VDC POWER



FRAME RACKS

FR-55

SCISSOR FRAME RACK MACHINE

- HANDLES BOTH FULL FRAME AND UNI-BODY VEHICLES
- SCISSOR STYLE OPERATION WITH 5,500LBS. CAPACITY
- UNIVERSAL ANCHORING SYSTEM WITH ADJUSTABLE HEIGHT PINCH WELD ASSEMBLIES
- ONE - 10 TON PULLING TOWER WITH DOWN PULL ROLLER
- MULTI ANGLE 360 DEGREE PULLING
- QUICK DISCONNECT HYDRAULIC FITTINGS
- ONE - 10' PULLING CHAIN WITH HOOK
- HIGH QUALITY AIR/HYDRAULIC PUMP WITH PRESSURE GAUGE
- FOUR UNIVERSAL WHEEL STANDS
- POWDER COAT FINISH



SCISSOR LIFT
OPERATION



FR-55-TBK20
20 PIECE FRAME RACK
TOOL BOARD & CLAMP KIT

OPTIONAL ACCESSORY

FRAME RACK TOOL BOARD KITS

THE IDEAL FRAME RACK TOOL KIT CONTAINS ALL OF THE NECESSARY CLAMPS, FIXTURES AND CHAIN TO GRIP, PULL AND HOLD DURING A TYPICAL STRAIGHTENING PROCEDURE. THE TOOL KIT COMES WITH A PORTABLE STORAGE BOARD CONSTRUCTED OF HEAVY GAUGE METAL WITH HOOKS AND SHELVES TO CONVENIENTLY ORGANIZE THE FRAME RACK TOOLS.

FRAME RACK SPECIFICATIONS

Frame Rack Model	FR-77-18	FR-77-20	FR-77T-20	FR-55
Deck Design	Steel Plate	Steel Plate	Tubular	Scissor Lift
Deck Length	18'	20'	20'	173.25"
Deck Width	82.6"	82.6"	82.6"	37"
Deck Height	19.7"	19.7"	19.7"	4.75" - 63"
Pull Force Per Tower	10 Ton	10 Ton	10 Ton	10 Ton
Hydraulic Pressure	10,000 PSI	10,000 PSI	10,000 PSI	10,000 PSI
Required Air Pressure	100 - 120 PSI	100 - 120 PSI	100 - 120 PSI	100 - 120 PSI
Lifting Capacity	7,700 lbs.	7,700 lbs.	7,700 lbs.	5,500 lbs.
Power	NA	NA	NA	220VAC - 20 AMP, 1PH
Ship Weight	5,071 lbs.	5,953 lbs.	5,300 lbs.	3,105 lbs.
Options	FR-77-TBK25 FR77 Tool Board Kit	FR-77-TBK25 FR77 Tool Board Kit	FR-77-TBK25 FR77 Tool Board Kit	FR-55-TBK20 FR55 Tool Board Kit

OPEN FRONT PAINT BOOTH



PSB-AFOFB1388-AK

IDEAL, OPEN FRONT PAINT BOOTH 1388

- TYPICALLY SHIPS WITHIN 48 HOURS!
- GREAT SOLUTION FOR INDUSTRIAL BATCH-TYPE & AUTOMATED PRODUCTION-TYPE FINISHING SYSTEMS FOR WOODEN & STEEL PRODUCTS.
- DELUXE CONTROL PANEL INCLUDED
- WHITE POWDER COAT PANEL FINISH - (INSIDE & OUTSIDE)
- HEAVY DUTY PRECISION PUNCHED 18 GAUGE PANEL CONSTRUCTION
- CONVENIENT 5/16" BOLT & SERRATED LOCK NUT ASSEMBLY
- UL LISTED DAYTON 24" TUBE-AXIAL EXHAUST FAN W/ SPARK RESISTANT FAN BLADES
- NEMA RATED 2HP-3 PHASE - 230/460VAC-60HZ MOTOR STANDARD
- PREMIUM AFC EXHAUST FILTERS
- LDPI INDUSTRIAL LIGHT FIXTURES W/ INSIDE ACCESS HINGED GLASS DOOR
- (2EA) LDPI INDUSTRIAL (CLS1 / DIV 2) LIGHT FIXTURES - UL & ETL (GROUPS A, B, C & D.)
- TRUE 'DAYLIGHT COLOR' W/ GE T8 48" FLORESCENT LAMPS 32W - 2900 LUMENS, 5000K
- OPTIMAL AIR FLOW W/ CFM 7,983 @ .5 STATIC PRESSURE
- INSIDE DIMENSIONS: 13' W X 8'-6" H X 7'-6" D
- ALL ASSEMBLY HARDWARE, MANOMETER & SEALANT INCLUDED
- MEETS AND/OR EXCEEDS ALL APPLICABLE OSHA & NFPA 33 REGULATIONS
- EASY TO INSTALL, OPERATE & MAINTAIN

Paint Booth Model	PSB-AFOFB1388-AK
Inside Dimensions	13'W X 8'-6"H X 7'-6"D
Outside Dimensions	13'-4"W X 8'-10"H X 10'-2"D
Fan / Motor	(1ea) - 24" Tube Axial Fan 2HP-3PH-230/460VAC-60HZ Non-Spark, NEMA Rated
CFM	7,983 @ .5 Static Pressure
Light Fixtures	(2ea) 48" 32W, T8 / 4 Bulb Light Fixtures UL & ETL Listed Cls1, Div2 - Groups A, B, C & D
Lamps	(8ea) T8 Florescent, 32W, 5000K - 48"L
Options	1 Phase Electrical Configuration
	8' Exhaust Duct Kit (25" Diameter)
	LED Lighting Upgrade Kit

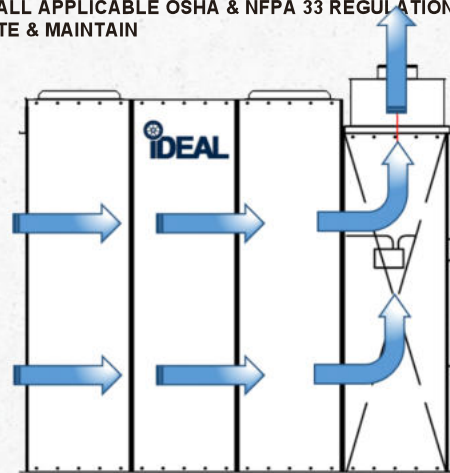

(Side View)

OPEN FRONT BOOTH ACCESSORIES



PSB-25DUCTKIT-8 KIT ASY

IDEAL, CROSS FLOW & SIDE DOWN DRAFT - 25" EXHAUST DUCT KIT - 8 FT.

- PROVIDES DUCT WORK TO PROPERLY EXHAUST PSB-PMR1088 MODEL
- 20 GAUGE GALVANIZED HAMMER SEAMED 'PLAIN PIPE' DUCTING
- ONE DUCT END CORRUGATED FOR EASY ASSEMBLY
- (1 PC) FAN CONNECTION RING
- (1 PC) 36"H X 13" DIA. SOLID DUCT W/ 32"H X 17"W CLEAN-OUT DOOR
- (1 PC) 36"H X 13" DIA. SOLID 'CENTER' DUCT
- (1 PC) 24"H X 13" DIA. AUTO ROOF VENTILATOR (ARV) PROTECTS FROM RAIN & SNOW
- SELF-TAPPING SCREW ASSEMBLY
- EXTEND DUCT KIT HEIGHT W/ ADDITIONAL 'CENTER' DUCT SECTION



PSB-PMROFB-LED UPGRDKIT

IDEAL, PSB MIXING RM & AF OPEN FRONT - LED LIGHTING UPGRADE KIT

- LDPI LED LIGHTING UPGRADE KIT FOR MIXING ROOM & OPEN FRONT BOOTH
- LONG LASTING, ENERGY EFFICIENT LED INDUSTRIAL LIGHTING
- REDUCES PAINT BOOTH OPERATIONAL COSTS
- INCREASES BOOTH BRIGHTNESS
- TWO ROW LEDS PROVIDING 5,000K CCT
- UL/ETL LISTED 120-277VAC (50/60HZ) ELECTRICAL
- DIRECT REPLACEMENT FOR STD. FLUORESCENT LIGHT FIXTURES

PAINT MIXING ROOM & CABINET / TABLE



PSB-PMR1088-AK

IDEAL, PAINT MIXING ROOM 1088

- TYPICALLY SHIPS WITHIN 48 HOURS!
- COMMERCIAL GRADE DESIGN FOR OPTIMAL AIR FLOW & LIGHTING COVERAGE
- DELUXE CONTROL PANEL INCLUDED
- WHITE POWDER COAT PANEL FINISH - (INSIDE & OUTSIDE)
- OPTIONAL DOOR PLACEMENT TO SIDE OR FRONT OF ROOM
- 'PRE-HUNG' 36"W PERSONNEL DOOR W/ VIEWING WINDOW
- HEAVY DUTY PRECISION PUNCHED 18 GAUGE PANEL CONSTRUCTION
- CONVENIENT 5/16" BOLT & SERRATED LOCK NUT ASSEMBLY
- UL LISTED DAYTON 12" TUBE-AXIAL EXHAUST FAN W/ SPARK RESISTANT FAN BLADES
- NEMA RATED 1/2HP-3 PHASE - 230/460VAC-60HZ MOTOR STANDARD
- PREMIUM AFC INTAKE & EXHAUST FILTERS
- LDPI INDUSTRIAL LIGHT FIXTURES W/ INSIDE ACCESS HINGED GLASS DOOR
- (2EA) LDPI INDUSTRIAL (CLS1 / DIV 2) LIGHT FIXTURES - UL & ETL (GROUPS A, B, C & D.)
- TRUE 'DAYLIGHT COLOR' W/ GE T8 48" FLORESCENT LAMPS 32W - 2900 LUMENS, 5000K
- OPTIMAL AIR FLOW W/ CFM 1,429 @ .5 STATIC PRESSURE
- INSIDE DIMENSIONS: 10' L X 8' W X 8' H
- ALL ASSEMBLY HARDWARE, MANOMETER & SEALANT INCLUDED
- MEETS AND/OR EXCEEDS ALL APPLICABLE OSHA & NFPA 33 REGULATIONS
- EASY TO INSTALL, OPERATE & MAINTAIN



Paint Booth Model	PSB-PMR1088-AK
Inside Dimensions	10'L X 8'W X 8'H or 8'L X 10'W X 8'H
Outside Dimensions	12'-6"L X 8'-4"W X 9'-4"H or 8'-4"L X 12'-6"W X 9'-4"H
Fan / Motor	(1ea) - 12" Tube Axial Fan 1/2 HP-3PH-208-230/460VAC-60HZ Non-Spark, UL Listed, NEMA Rated
CFM	1,429 @ .5 Static Pressure
Light Fixtures	(2ea) 48" 32W, T8 / 4 Bulb Light Fixtures UL & ETL Listed Cls1, Div2 - Groups A, B, C & D
Lamps	(8ea) T8 Florescent, 32W, 5000K - 48"L
Options	Single Phase Electrical Configuration 8" Exhaust Duct Kit (13" Diameter)

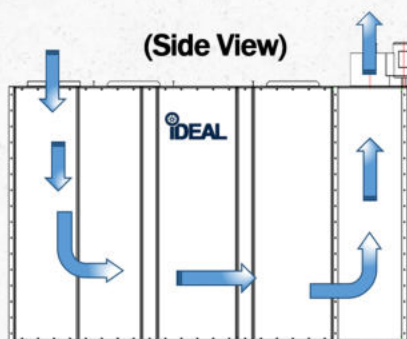

PAINT ROOM MIXING ACCESSORIES

PSB-13DUCTKIT-8 KIT ASY

IDEAL, PAINT MIXING ROOM 1088 - 13" EXHAUST DUCT KIT - 8 FT.

- PROVIDES DUCT WORK TO PROPERLY EXHAUST PSB-PMR1088 MODEL
- 20 GAUGE GALVANIZED HAMMER SEAMED 'PLAIN PIPE' DUCTING
- ONE DUCT END CORRUGATED FOR EASY ASSEMBLY
- (1 PC) FAN CONNECTION RING
- (1 PC) 36"H X 13" DIA. SOLID DUCT W/ 32"H X 17"W CLEAN-OUT DOOR
- (1 PC) 36"H X 13" DIA. SOLID 'CENTER' DUCT
- (1 PC) 24"H X 13" DIA. AUTO ROOF VENTILATOR (ARV) PROTECTS FROM RAIN & SNOW
- SELF-TAPPING SCREW ASSEMBLY
- EXTEND DUCT KIT HEIGHT W/ ADDITIONAL 'CENTER' DUCT SECTION



PSB-PMROFB-LED UPGRDKIT

IDEAL, PSB MIXING RM & AF OPEN FRONT LED LIGHTING UPGRADE KIT

- LDPI LED LIGHTING UPGRADE KIT FOR MIXING ROOM & OPEN FRONT BOOTH
- LONG LASTING, ENERGY EFFICIENT LED INDUSTRIAL LIGHTING
- REDUCES PAINT BOOTH OPERATIONAL COSTS
- INCREASES BOOTH BRIGHTNESS
- TWO ROW LEDS PROVIDING 5,000K CCT
- UL/ETL LISTED 120-277VAC (50/60HZ) ELECTRICAL
- DIRECT REPLACEMENT FOR STD. FLUORESCENT LIGHT FIXTURES

PAINT MIXING ROOM CABINET & TABLE DISPENSER

PSB-PSMCT

IDEAL, PAINT STORAGE MIXING CABINET & TABLE

- HEAVY-DUTY STAINLESS-STEEL CONSTRUCTION
- LARGE LOCKABLE STORAGE CABINET
- (2) SIDE DRAWERS & STORAGE BINS
- CONVENIENT 34" TABLE HEIGHT
- LARGE 46" X 20" TABLETOP AREA
- 1.25" RETAINING FENCE ON THREE SIDES
- SHIPS FULLY ASSEMBLED



PSB-PSMTD

IDEAL, PAINT STORAGE MIXING TABLE & DISPENSER

- HEAVY-DUTY STAINLESS-STEEL CONSTRUCTION
- DUAL SPRAY GUN HOLDER W/ CATCH BASIN
- (2) TAPE & PAPER MASKING DISPENSERS
- PORTABLE DESIGN W/ 3" POLY CASTERS
- CONVENIENT 32" TABLE HEIGHT
- LARGE 37" X 22" TABLETOP AREA
- MINOR ASSEMBLY REQUIRED



CROSS FLOW PAINT BOOTH



PSB-AFCF23B-AK

CROSS FLOW DRAFT - PAINT SPRAY BOOTH

- TYPICALLY SHIPS WITHIN 48 HOURS!
- HEAVY DUTY PRECISION PUNCHED 18 GAUGE PANEL CONSTRUCTION
- OPTIMAL 'CROSS DRAFT' AIR FLOW W/ CFM 9,500 @ .5 STATIC PRESSURE
- TILT PANEL DESIGN FOR OPTIMAL LIGHTING COVERAGE
- INSIDE DIMENSIONS: 22'-6" L X 13' W X 8'-6" H
- CONVENIENT 5/16" BOLT & NUT ASSEMBLY
- DELUXE CONTROL PANEL INCLUDED
- WHITE POWDER COAT PANEL FINISH - (INSIDE & OUTSIDE)
- MANOMETER, SOLENOID VALVE, HARDWARE & SEALANT INCLUDED
- UL LISTED DAYTON 24" TUBE-AXIAL EXHAUST FAN W/ SPARK RESISTANT FAN BLADES
- NEMA RATED 3HP-3 PHASE - 230/460VAC-60HZ MOTORS STANDARD
- PREMIUM AFC INTAKE & EXHAUST FILTERS
- (6EA) LDPI INDUSTRIAL LIGHTING T-8 'VERTICAL' LIGHT FIXTURES, 4 LAMP
- (24EA) GE T8 FLORESCENT LAMPS - 32W, 5000K 4' LENGTH
- DOUBLE ENTRY DOORS W/ SHUTOFF SWITCHES
- PERSONNEL DOOR W/ VIEWING WINDOW & SHUTOFF SWITCH
- MEETS AND/OR EXCEEDS ALL APPLICABLE OSHA & NFPA 33 REGULATIONS
- EASY TO INSTALL, OPERATE & MAINTAIN

Paint Booth Model	PSB-AFCF23B-AK
Inside Dimensions	22'-6" L X 13' W X 8'-6" H
Outside Dimensions	25'-4" L X 13'-4" W X 8'-10" H
Fan / Motor	24" Tube Axial Fan 3HP-3PH-230/460VAC-60HZ Non-Spark, NEMA Rated
CFM	9,500 @ .5 Static Pressure
Lighting	6 Each T-8 / 4 Bulb Light Fixtures
Options	1 Phase Electrical Configuration
	8' Exhaust Duct Kit (25" Diameter)
	LED Lighting Upgrade Kit

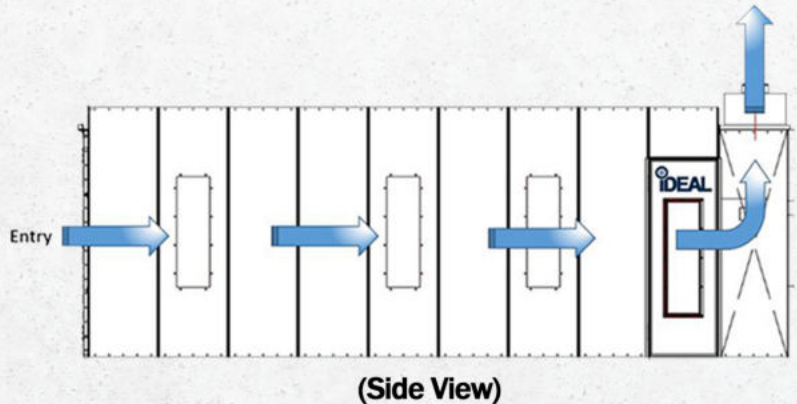

MORE FEATURES, MORE VALUE!



CROSS FLOW PAINT BOOTH ACCESSORIES

PSB-25DUCTKIT-8 KIT ASY

IDEAL, CROSS FLOW & SIDE DOWN DRAFT - 25" EXHAUST DUCT KIT - 8 FT.

- PROVIDES DUCT WORK TO PROPERLY EXHAUST SPRAY BOOTH
- 20 GAUGE GALVANIZED HAMMER SEAMED 'PLAIN PIPE' DUCTING
- ONE DUCT END CORRUGATED FOR EASY ASSEMBLY
- (1 PC) FAN CONNECTION RING
- (1 PC) 36"H X 25" DIA. SOLID DUCT W/ 32"H X 17"W CLEAN-OUT DOOR
- (1 PC) 36"H X 25" DIA. SOLID 'CENTER' DUCT
- (1 PC) 24"H X 25" DIA. AUTO ROOF VENTILATOR (ARV) PROTECTS FROM RAIN & SNOW
- SELF-TAPPING SCREW ASSEMBLY
- EXTEND DUCT KIT HEIGHT W/ ADDITIONAL 'CENTER' DUCT SECTION



PSB-AFCF23-LED UPGRDKIT

IDEAL, CROSS FLOW & SIDE DOWN DRAFT - 25" EXHAUST DUCT KIT - 8 FT.

- LDPI LED LIGHTING UPGRADE KIT FOR PSB-AFCF MODEL
- LONG LASTING, ENERGY EFFICIENT LED INDUSTRIAL LIGHTING
- REDUCES PAINT BOOTH OPERATIONAL COSTS
- INCREASES BOOTH BRIGHTNESS
- TWO ROW LEDS PROVIDING 5,000K CCT
- UL/ETL LISTED 120-277VAC (50/60HZ) ELECTRICAL
- DIRECT REPLACEMENT FOR STD. FLUORESCENT LIGHT FIXTURES



PSB-AFCF-30LEPK-LED UPGRDKIT

IDEAL, PSBAFCF-30" LIGHT EXT. PANEL KIT ASSY - LED LIGHTING UPGRADE KIT

- LDPI LED LIGHTING UPGRADE KIT FOR PSB-AFCF 30" LIGHT EXTENSION KIT

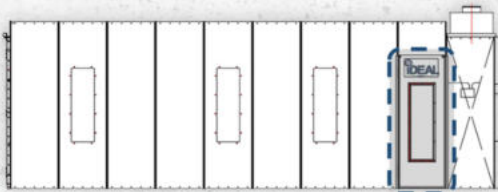

PSB-PSDK-AK

IDEAL, CROSS FLOW - PERSONNEL SIDE DOOR KIT

- ADDITIONAL PERSONNEL SIDE DOOR FOR PSB-AFCF23 MODEL
- WHITE POWDER COAT DOOR FINISH - (INSIDE & OUTSIDE)
- PERSONNEL DOOR SIZE 30"W X 84"H
- VIEWING WINDOW INCLUDED
- HEAVY DUTY DUAL SKIN CONSTRUCTION
- HIGH QUALITY HINGES, PRESSURE LATCH & HANDLES
- DOOR ACTIVATED SHUTOFF SWITCH
- CONVENIENT 5/16" BOLT & NUT ASSEMBLY
- ALL ASSEMBLY HARDWARE INCLUDED

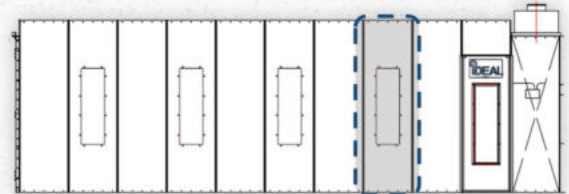
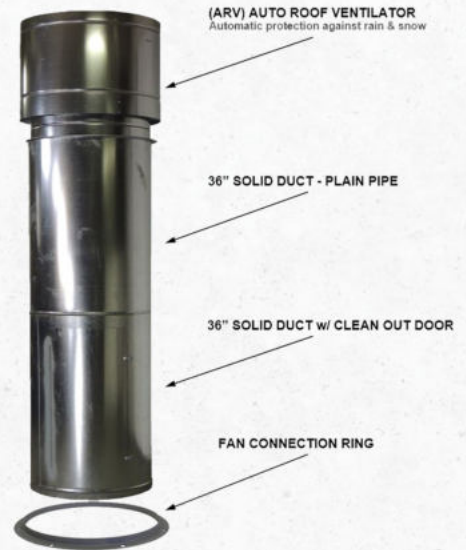

PSB-AFCF-30LEPK-AK

IDEAL, CROSS FLOW - 'LIGHT' EXTENSION PANEL KIT.

- 30" LIGHTED, REAR BOOTH EXTENSION
- WHITE POWDER COAT PANEL FINISH - (INSIDE & OUTSIDE)
- HEAVY DUTY PRECISION PUNCHED 18 GAUGE PANEL CONSTRUCTION
- CONVENIENT 5/16" BOLT & NUT ASSEMBLY
- (2EA) LDPI INDUSTRIAL LIGHTING T-8 'VERTICAL' LIGHT FIXTURES, 4 LAMP
- (8EA) GE T8 FLORESCENT LAMPS - 32W, 5000K 4' LENGTH
- ALL ASSEMBLY HARDWARE INCLUDED

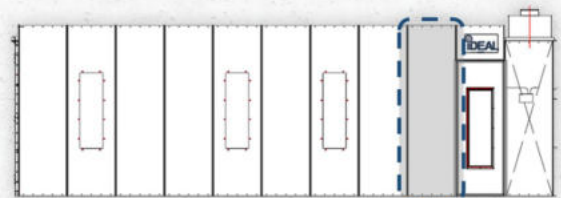

PSB-30SEPK-AK

IDEAL, CROSS FLOW - 'SOLID' EXTENSION PANEL KIT

- 30" SOLID, REAR BOOTH EXTENSION
- WHITE POWDER COAT PANEL FINISH - (INSIDE & OUTSIDE)
- HEAVY DUTY PRECISION PUNCHED 18 GAUGE PANELS
- CONVENIENT 5/16" BOLT & NUT ASSEMBLY
- ALL ASSEMBLY HARDWARE INCLUDED



SEMI DOWN DRAFT PAINT BOOTH



PSB-SEMIDD26B-AK

IDEAL, SEMI DOWN DRAFT PAINT SPRAY BOOTH

- TYPICALLY SHIPS WITHIN 48 HOURS!
- HEAVY DUTY PRECISION PUNCHED 18 GAUGE PANEL CONSTRUCTION
- OPTIMAL AIR FLOW W/ CFM 12,200 @ .5 STATIC PRESSURE
- COMMERCIAL GRADE 'HIP PANEL' DESIGN FOR OPTIMAL LIGHTING COVERAGE
- INSIDE DIMENSIONS: 26' L X 14' W X 9' 3" H
- CONVENIENT 5/16" BOLT & NUT ASSEMBLY
- DELUXE CONTROL PANEL INCLUDED
- WHITE POWDER COAT PANEL FINISH - (INSIDE & OUTSIDE)
- MANOMETER, SOLENOID VALVE, HARDWARE & SEALANT INCLUDED
- UL LISTED DAYTON 30" TUBE-AXIAL EXHAUST FAN W/ SPARK RESISTANT FAN BLADES
- NEMA RATED 3HP-3 PHASE - 230/460VAC-60HZ MOTORS STANDARD
- PREMIUM AFC INTAKE & EXHAUST FILTERS
- (10EA) LDPI INDUSTRIAL LIGHTING T-8 'VERTICAL' LIGHT FIXTURES, 4 LAMP
- (40EA) GE T8 FLORESCENT LAMPS - 32W, 5000K 4' LENGTH
- TRI-FOLD ENTRY DOORS W/ VIEWING WINDOWS & SHUTOFF SWITCH
- PERSONNEL DOOR W/ VIEWING WINDOW & SHUTOFF SWITCH
- MEETS AND/OR EXCEEDS ALL APPLICABLE OSHA & NFPA 33 REGULATIONS
- EASY TO INSTALL, OPERATE & MAINTAIN

Paint Booth Model	PSB-SEMIDD26B-AK
Inside Dimensions	26'L X 14'W X 9'-3"H
Outside Dimensions	29'-4"L X 14'-4"W X 9'-7"H
Fan / Motor	30" Tube Axial Fan 3HP-3PH-230/460VAC-60HZ Non-Spark, NEMA Rated
CFM	12,200 @ .5 Static Pressure
Lighting	10 Each T-8 / 4 Bulb Light Fixtures
Options	1 Phase Electrical Configuration
	8' Exhaust Duct Kit (31" Diameter)
	LED Lighting Upgrade Kit

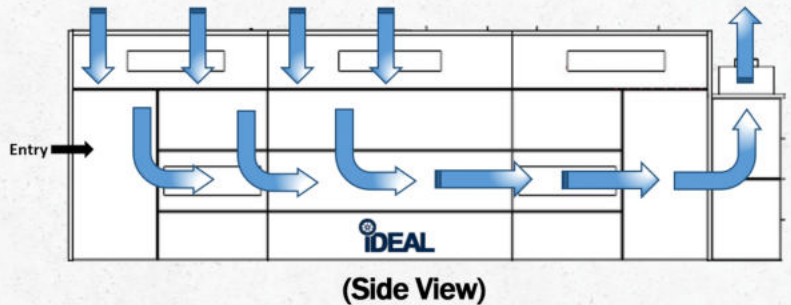

MORE FEATURES, MORE VALUE!

'OPTIONAL' PLENUM KIT FOR PRESSURIZED HEATED BOOTH CONFIGURATION

'TRUE DAYLIGHT' T8, 48" FLORESCENT LAMPS
32W, 5000K COLOR

PERSONNEL DOOR LOCATION OPTIONS

TRI-FOLD ENTRY DOORS WITH VIEWING WINDOWS



DURABLE WHITE POWDER-COAT FINISH (INSIDE & OUTSIDE)

OPTIMAL LIGHTING COVERAGE WITH 'HIP PANEL' DESIGN

HEAVY DUTY, PRECISION PUNCHED 18 GAUGE PANELS

CONVENIENT 5/16" BOLT & LOCK NUT ASSEMBLY



SEMI DOWN PAINT BOOTH ACCESSORIES

PSB-31DUCTKIT-8 KIT ASY

IDEAL, SEMI DOWN DRAFT - 31" EXHAUST DUCT KIT - 8 FT.

- PROVIDES DUCT WORK TO PROPERLY EXHAUST PSB-SEMIDD26 MODEL
- 20 GAUGE GALVANIZED HAMMER SEAMED 'PLAIN PIPE' DUCTING
- ONE DUCT END CORRUGATED FOR EASY ASSEMBLY
- (1 PC) FAN CONNECTION RING
- (1 PC) 36"H X 31" DIA. SOLID DUCT W/ 32"H X 17"W CLEAN-OUT DOOR
- (1 PC) 36"H X 31" DIA. SOLID 'CENTER' DUCT
- (1 PC) 24"H X 31" DIA. AUTO ROOF VENTILATOR (ARV) PROTECTS FROM RAIN & SNOW
- SELF-TAPPING SCREW ASSEMBLY
- EXTEND DUCT KIT HEIGHT W/ ADDITIONAL 'CENTER' DUCT SECTION

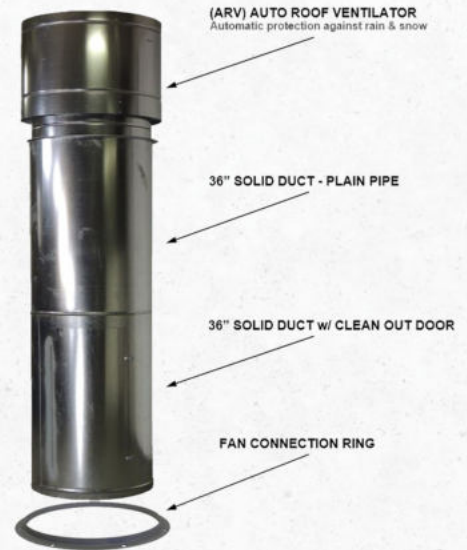

PSB-SSDD26-LED UPGRDKIT

IDEAL, PSBSSDD SDD & SEMI - LED LIGHTING UPGRADE KIT

- LDPI LED LIGHTING UPGRADE KIT FOR PSB-SDD & PSB SEMIDD MODELS
- LONG LASTING, ENERGY EFFICIENT LED INDUSTRIAL LIGHTING
- REDUCES PAINT BOOTH OPERATIONAL COSTS
- INCREASES BOOTH BRIGHTNESS
- TWO ROW LEDS PROVIDING 5,000K CCT
- UL/ETL LISTED 120-277VAC (50/60HZ) ELECTRICAL
- DIRECT REPLACEMENT FOR STD. FLUORESCENT LIGHT FIXTURES

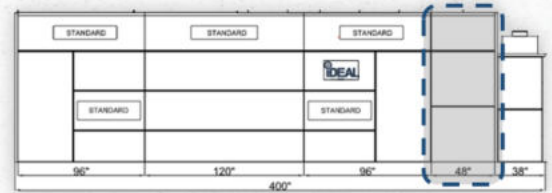

PSB-SSDD-48EPK-AK

IDEAL, SEMI & SIDE DOWN DRAFT - 48" EXTENSION PANEL KIT.

- 48" SOLID, REAR BOOTH EXTENSION
- WHITE POWDER COAT PANEL FINISH - (INSIDE & OUTSIDE)
- HEAVY DUTY PRECISION PUNCHED 18 GAUGE PANEL CONSTRUCTION
- CONVENIENT 5/16" BOLT & NUT ASSEMBLY
- ALL ASSEMBLY HARDWARE INCLUDED

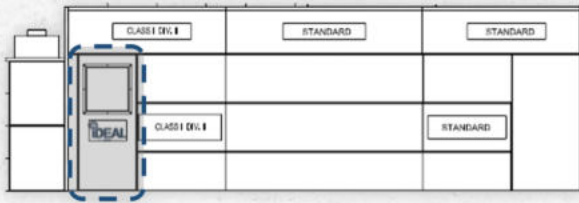

PSB-SSDD-PSDK-AK

IDEAL, SEMI & SIDE DOWN DRAFT - PERSONNEL SIDE DOOR KIT

- ADDITIONAL PERSONNEL SIDE DOOR FOR PSB-SEMI & PSB-SDD MODELS
- WHITE POWDER COAT DOOR FINISH - (INSIDE & OUTSIDE)
- PERSONNEL DOOR SIZE 36"W X 84"H
- VIEWING WINDOW INCLUDED
- HEAVY DUTY DUAL SKIN CONSTRUCTION
- HIGH QUALITY HINGES, PRESSURE LATCH & HANDLES
- DOOR ACTIVATED SHUTOFF SWITCH
- CONVENIENT 5/16" BOLT & NUT ASSEMBLY
- ALL ASSEMBLY HARDWARE INCLUDED

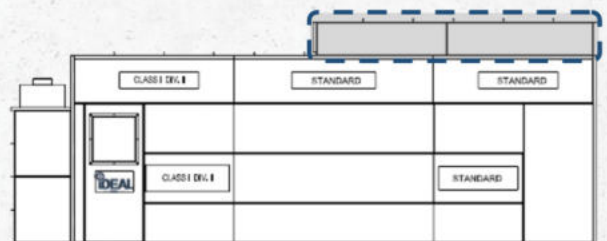

PSB-SEMIDD26B-PLENUM KIT ASY

IDEAL, SEMI DOWN DRAFT - PLENUM KIT

- REQUIRED WHEN USING DIRECT 'GAS FIRED' AIR MAKE UP (HEATER) WITH PAINT BOOTH
- CAN BE INSTALLED TO NEW OR EXISTING IDEAL SEMI DOWN DRAFT PAINT BOOTHS
- WHITE POWDER COAT PANEL FINISH - (INSIDE & OUTSIDE)
- HEAVY DUTY PRECISION PUNCHED 18 GAUGE PANEL CONSTRUCTION
- CONVENIENT 5/16" BOLT & NUT ASSEMBLY
- ALL ASSEMBLY HARDWARE & SEALANT INCLUDED



SIDE DOWN DRAFT PAINT BOOTH

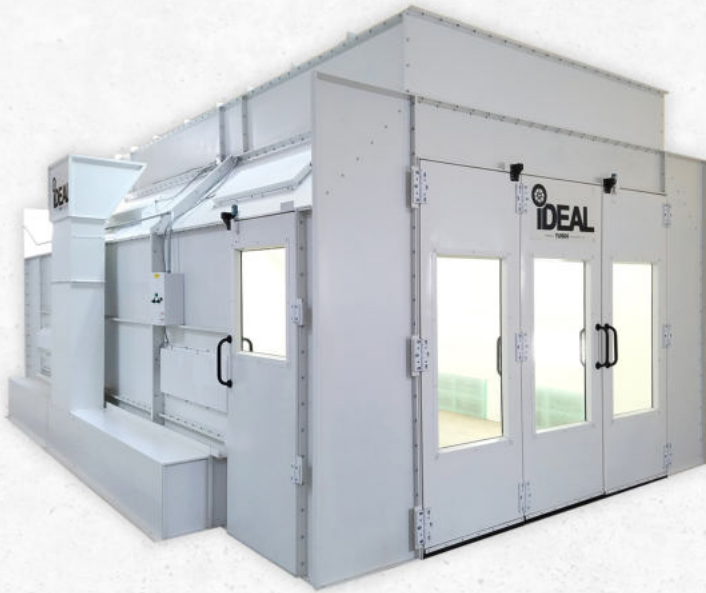

PSB-SDD26B-AK

IDEAL, SIDE DOWN DRAFT PAINT SPRAY BOOTH

- TYPICALLY SHIPS WITHIN 48 HOURS!
- HEAVY DUTY PRECISION PUNCHED 18 GAUGE PANEL CONSTRUCTION
- OPTIMAL AIR FLOW W/ CFM 14,000 @ .5 STATIC PRESSURE
- COMMERCIAL GRADE 'HIP PANEL' DESIGN FOR OPTIMAL LIGHTING COVERAGE
- INSIDE DIMENSIONS: 26' L X 14' W X 9' 3" H
- CONVENIENT 5/16" BOLT & NUT ASSEMBLY
- DELUXE CONTROL PANEL INCLUDED
- WHITE POWDER COAT PANEL FINISH - (INSIDE & OUTSIDE)
- MANOMETER, SOLENOID VALVE, HARDWARE & SEALANT INCLUDED
- (2EA) UL LISTED DAYTON 24" TUBE-AXIAL EXHAUST FAN W/ SPARK RESISTANT FAN BLADES
- NEMA RATED 3HP-3 PHASE - 230/460VAC-60HZ MOTORS STANDARD
- PREMIUM AFC INTAKE & EXHAUST FILTERS
- (10EA) LDPI INDUSTRIAL LIGHTING T-8 'VERTICAL' LIGHT FIXTURES, 4 LAMP
- (40EA) GE T8 FLORESCENT LAMPS - 32W, 5000K 4' LENGTH
- TRI-FOLD ENTRY DOORS W/ VIEWING WINDOWS & SHUTOFF SWITCH
- PERSONNEL DOOR W/ VIEWING WINDOW & SHUTOFF SWITCH
- MEETS NFPA 33 STANDARDS
- OPTIONAL: 1PH ELECTRICAL, PLENUM KIT, TRI-FOLD DRIVE-THRU & PERSONNEL DOOR KITS & BOOTH EXTENSION KIT

Paint Booth Model	PSB-SDD26B-AK
Inside Dimensions	26'L X 14'W X 9'-3"H
Outside Dimensions	26'-4"L X 17'-8"W X 9'-5"H
Fan / Motor	(2ea) - 24" Tube Axial Fans 2HP-3PH-230/460VAC-60HZ Non-Spark, NEMA Rated
CFM	14,000 @ .5 Static Pressure
Lighting	10 Each T-8 / 4 Bulb Light Fixtures
Options	1 Phase Electrical Configuration
	8' Exhaust Duct Kits (25" Diameter)
	LED Lighting Upgrade Kit

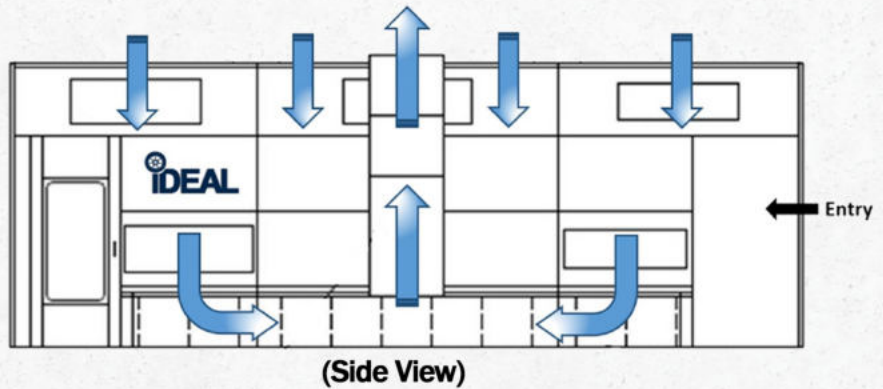

MORE FEATURES, MORE VALUE!

OPTIMAL LIGHTING
COVERAGE WITH
'HIP PANEL' DESIGN

ELEVATED TUBE-AXIAL
FANS REDUCE BOOTH
NOISE LEVEL

HEAVY DUTY,
PRECISION PUNCHED
18 GAUGE PANELS

CONVENIENT 5/16"
BOLT & LOCK NUT
ASSEMBLY

PERSONNEL DOOR
LOCATION OPTIONS

'OPTIONAL' PLENUM KIT FOR PRESSURIZED
HEATED BOOTH CONFIGURATION

DURABLE WHITE
POWDER-COAT FINISH
(INSIDE & OUTSIDE)

'TRUE DAYLIGHT' T8, 48"
FLORESCENT LAMPS
32W, 5000K COLOR

TRI-FOLD ENTRY DOORS
WITH VIEWING WINDOWS

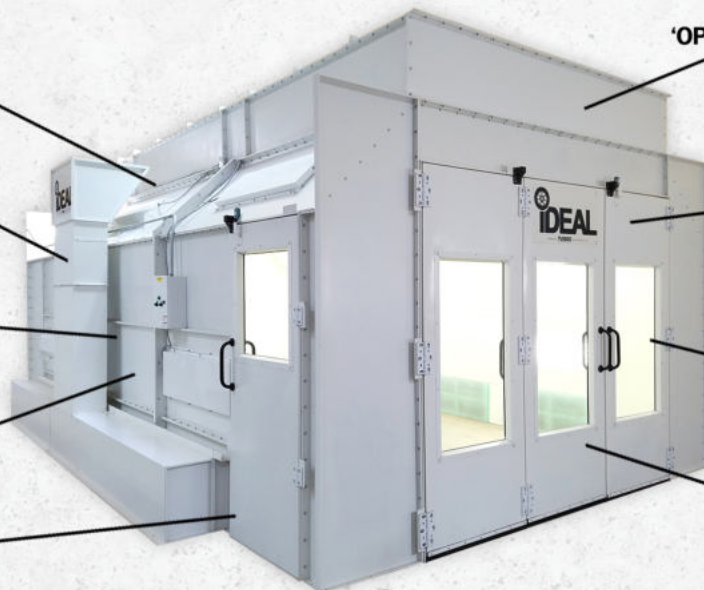

SIDE DOWN PAINT BOOTH ACCESSORIES

PSB-25DUCTKIT-8 KIT ASY

IDEAL, CROSS FLOW & SIDE DOWN DRAFT - 25" EXHAUST DUCT KIT - 8 FT.

- PROVIDES DUCT WORK TO PROPERLY EXHAUST SPRAY BOOTH
- 20 GAUGE GALVANIZED HAMMER SEAMED 'PLAIN PIPE' DUCTING
- ONE DUCT END CORRUGATED FOR EASY ASSEMBLY
- (1 PC) FAN CONNECTION RING
- (1 PC) 36"H X 25" DIA. SOLID DUCT W/ 32"H X 17"W CLEAN-OUT DOOR
- (1 PC) 36"H X 25" DIA. SOLID 'CENTER' DUCT
- (1 PC) 24"H X 25" DIA. AUTO ROOF VENTILATOR (ARV) PROTECTS FROM RAIN & SNOW
- SELF-TAPPING SCREW ASSEMBLY
- EXTEND DUCT KIT HEIGHT W/ ADDITIONAL 'CENTER' DUCT SECTION

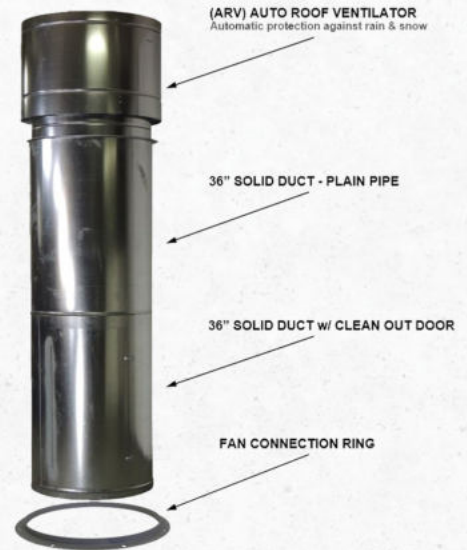

PSB-SSDD26-LED UPGRDKIT

IDEAL, PSBSSDD SDD & SEMI - LED LIGHTING UPGRADE KIT

- LDPI LED LIGHTING UPGRADE KIT FOR PSB-SDD & PSB SEMIDD MODELS
- LONG LASTING, ENERGY EFFICIENT LED INDUSTRIAL LIGHTING
- REDUCES PAINT BOOTH OPERATIONAL COSTS
- INCREASES BOOTH BRIGHTNESS
- TWO ROW LEDS PROVIDING 5,000K CCT
- UL/ETL LISTED 120-277VAC (50/60HZ) ELECTRICAL
- DIRECT REPLACEMENT FOR STD. FLUORESCENT LIGHT FIXTURES

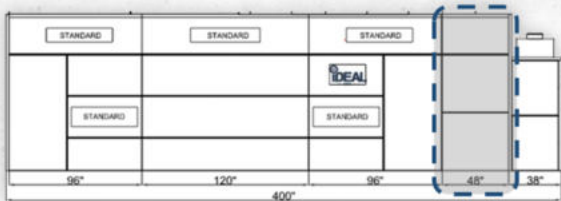
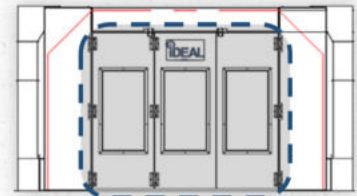

PSB-SDD-TF-DTDK-AK

IDEAL, SIDE DOWN DRAFT - TRI-FOLD 'DRIVE-THRU' DOOR KIT

- ALLOWS DRIVE-THRU CONFIGURATION FOR IDEAL PSB-SDD MODEL
- WHITE POWDER COAT DOOR FINISH - (INSIDE & OUTSIDE)
- STANDARD W/ INTEGRATED PERSONNEL DOOR
- VIEWING WINDOWS INCLUDED
- HEAVY DUTY DUAL SKIN CONSTRUCTION
- HIGH QUALITY HINGES, PRESSURE LATCH & HANDLES
- DOOR ACTIVATED SHUTOFF SWITCH
- CONVENIENT 5/16" BOLT & NUT ASSEMBLY
- ALL ASSEMBLY HARDWARE INCLUDED

PSB-SSDD-48EPK-AK

IDEAL, SEMI & SIDE DOWN DRAFT - 48" EXTENSION PANEL KIT.

- 48" SOLID, REAR BOOTH EXTENSION
- WHITE POWDER COAT PANEL FINISH - (INSIDE & OUTSIDE)
- HEAVY DUTY PRECISION PUNCHED 18 GAUGE PANEL CONSTRUCTION
- CONVENIENT 5/16" BOLT & NUT ASSEMBLY
- ALL ASSEMBLY HARDWARE INCLUDED

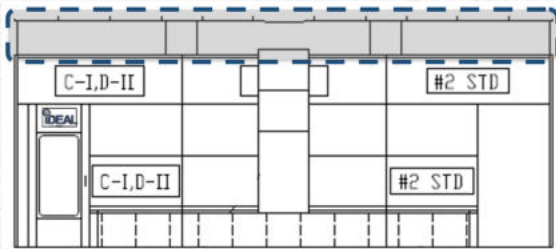
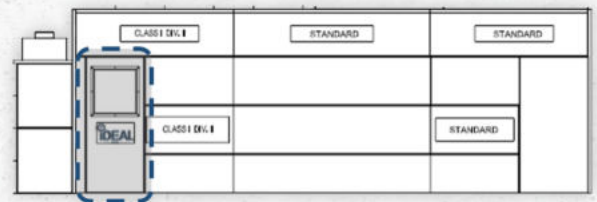

PSB-SSDD-PSDK-AK

IDEAL, SEMI & SIDE DOWN DRAFT - PERSONNEL SIDE DOOR KIT

- ADDITIONAL PERSONNEL SIDE DOOR FOR PSB-SEMI & PSB-SDD MODELS
- WHITE POWDER COAT DOOR FINISH - (INSIDE & OUTSIDE)
- PERSONNEL DOOR SIZE 36"W X 84"H
- VIEWING WINDOW INCLUDED
- HEAVY DUTY DUAL SKIN CONSTRUCTION
- HIGH QUALITY HINGES, PRESSURE LATCH & HANDLES
- DOOR ACTIVATED SHUTOFF SWITCH
- CONVENIENT 5/16" BOLT & NUT ASSEMBLY
- ALL ASSEMBLY HARDWARE INCLUDED

PSB-SDD26B-PLENUM KIT ASY

IDEAL, SIDE DOWN DRAFT - PLENUM KIT

- REQUIRED WHEN USING DIRECT 'GAS FIRED' AIR MAKE UP (HEATER) WITH PAINT BOOTH
- CAN BE INSTALLED TO NEW OR EXISTING IDEAL SIDE DOWN DRAFT PAINT BOOTHS
- WHITE POWDER COAT PANEL FINISH - (INSIDE & OUTSIDE)
- HEAVY DUTY PRECISION PUNCHED 18 GAUGE PANEL CONSTRUCTION
- CONVENIENT 5/16" BOLT & NUT ASSEMBLY
- ALL ASSEMBLY HARDWARE & SEALANT INCLUDED



PAINT BOOTH HEAT UNITS (AMU)



Included with Stand and Filter Box, and Aluminum Filters



Intertek

RAMMSTEIN AIR

Energy Efficient Finishing Systems

RS-1001

DIRECT FIRED HEATING SYSTEM

- EASY TO OPERATE & MAINTAIN
- HIGH QUALITY, PROFESSIONAL GRADE PAINT BOOTH HEATING
- OPERATES W/ NATURAL GAS OR PROPANE
- DELUXE CONTROL PANEL WITH HOUR METER & STATUS MESSAGES
- TIME DISPLAYS FOR CYCLE TIME & ELAPSED TIME
- VARIFLOW TECHNOLOGY
- EXHAUST VFD FUSED & WIRED
- VERTICAL / SIDE DISCHARGE CONFIGURATION
- DURABLE WHITE POWDER COAT PANEL FINISH - (INSIDE & OUTSIDE)
- VERTICAL STAND, FILTER BOX & FILTERS INCLUDED
- SINGLE POINT CONNECTION WITH 30' UMBILICAL CORD
- INTERLOCK STATUS INDICATOR LIGHTS
- STANDARD: 3 PH ELECTRICAL
- OPTIONAL: 1 PH ELECTRICAL
- ETL LISTED

RS-3001-EHS-30KW

ELECTRIC HEATING SYSTEM

- EASY TO OPERATE & MAINTAIN
- ECONOMICAL, ENERGY EFFICIENT PAINT BOOTH HEATING SOLUTION
- DELUXE CONTROL PANEL INCLUDED
- PRE-HEAT, FLASH-OFF, SPRAY & BAKE SELECT MODES
- TEMPERATURE RISE: 30F IN 10 MINUTES / 50F IN 50 MINUTES
- SINGLE POINT CONNECTION W/ UMBILICAL CORD
- INTAKE FILTER & DUCT PACKAGE INCLUDED
- 2HP BLOWER (208VAC OR 230VAC - 3PH 6.3A)
- 30KW ELECTRIC HEATER (208VAC OR 230VAC - 3PH 85A)
- UNIQUE PULSING MECHANISM W/ PNEUMATIC ACTUATORS
- STANDARD: 3 PH ELECTRICAL
- OPTIONAL: 1 PH ELECTRICAL
- PATENT PENDING DESIGN

RAMMSTEIN AIR

Energy Efficient Finishing Systems

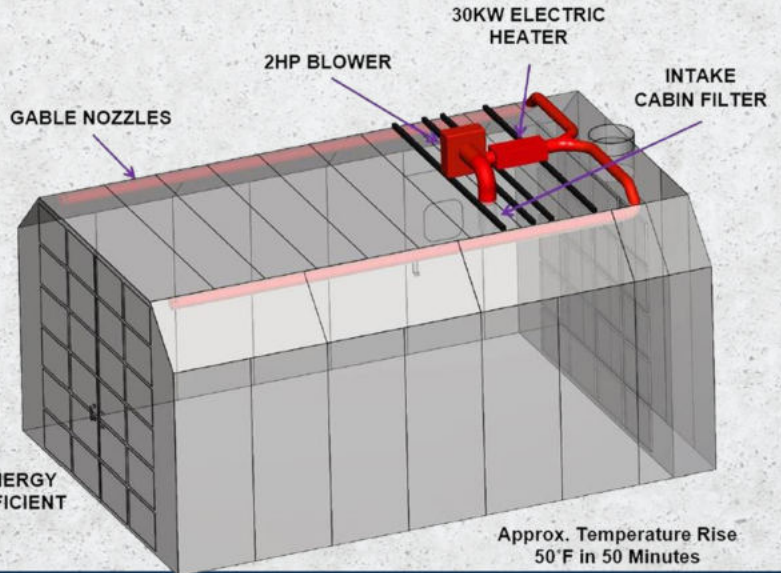

PAINT BOOTH / HEAT UNIT SPECIFICATIONS

AMU Heater Model	RS-1001 - 3 Phase	RS-1001 - 1 Phase	RS-3001
Fuel	NG or LP	NG or LP	Electric
BTUH	1.2M	1.2M	NA
Gas Train	1"	1"	NA
CFM	13,000	13,000	NA
Intake Motor	230V - 10HP - 3 PH	230V - 10HP - 3 PH	NA
Exhaust VFD	230V - 5HP - 3PH	230V - 10HP - 3PH	NA
Blower Motor	NA	NA	2HP / 208VAC or 230VAC / 3Phase / 6.3A
Heating Element	NA	NA	30KW / 208VAC or 230VAC / 3 Phase / 85A
Temperature Rise	NA	NA	Approx. 30°F in 10 Minutes / 50°F in 50 Minutes
Ship Weight	1,395 lbs.	1,395 lbs.	560 lbs
PSB Model Usage	Side Down & Semi Down Draft (Plenum / Canopy Required)	Side Down & Semi Down Draft (Plenum / Canopy Required)	Cross Flow, Side Down & Semi Down Draft

POWER UNITS

DURO
HYDRAULICS

PU-110V-S-K
DURO 110 VOLT
SHORT TANK



PU-110V-L-K
DURO 110 VOLT
LONG TANK



PU-220V-L-H
DURO 220 VOLT
WITH CUT OFF



PU-220V-L-H-X
DURO 220 VOLT
WITHOUT CUT OFF



DURO POWER UNITS				
Power Unit Model	PU-110V-S-K	PU-110V-L-K	PU-220V-L-H	PU-220V-L-H-X
Power	115VAC/60HZ/1PH	115VAC/60HZ/1PH	208-230VAC/60HZ/1PH	208-230VAC/60HZ/1PH
Motor	2.5HP	2.5HP	2.5HP	2.5HP
Amps	20	20	14.5 - 16.5	14.5 - 16.5
RPM	3450	3450	3450	3450
PSI	3050	3050	3050	3050
Tank Capacity	1.5 Gallon	3.5 Gallon	3.5 Gallon	3.5 Gallon



DURO MET CERTIFIED POWER UNITS				
Power Unit Model	PU-AC-115V-1.5-3050	PU-AC-115V-3.5-3050	PU-AC-220V-OKS-3.5-3050	PU-AC-220V-3.5-3050
Power	115VAC/60HZ/1PH	115VAC/60HZ/1PH	208-230VAC/60HZ/1PH	208-230VAC/60HZ/1PH
Motor	1.5HP	1.5HP	3.0HP	3.0HP
Amps	15	15	14 - 15	14 - 15
RPM	3450	3450	3450	3450
PSI	3050	3050	3050	3050
Tank Capacity	1.5 Gallon	3.5 Gallon	3.5 Gallon	3.5 Gallon

DURO POWER UNITS

- MANUAL RELEASE VALVE
- MOUNTING HARDWARE INCLUDED
- INCLUDES O/H CUTOFF (PU-220V-L-H ONLY)
- POWER PORT 9/16-18 O-RING

DURO MET CERTIFIED POWER UNITS

- MET / UL / CSA LISTED
- MANUAL RELEASE VALVE
- MOUNTING HARDWARE INCLUDED
- INCLUDES O/H CUTOFF (PU-AC220-OKS-3.5-3050) ONLY
- POWER PORT 9/16-18 O-RING



SPXFLOW

PU-110V-S-S
SPX 110 VOLT
SHORT TANK



PU-110V-L-S
SPX 110 VOLT
LONG TANK



PU-S-AB-1270
SPX 220 VOLT
WITH CUT OFF



SPX ETL CERTIFIED POWER UNITS

- ETL / UL / CSA LISTED
- MANUAL RELEASE VALVE
- MOUNTING HARDWARE INCLUDED
- INCLUDES O/H CUTOFF (PU-S-AB-1270 ONLY)
- POWER PORT 9/16-18 O-RING

SPX ETL CERTIFIED POWER UNITS			
Power Unit Model	PU-110V-S-S	PU-110V-L-S	PU-S-AB-1270
Power	115VAC/60HZ/1PH	115VAC/60HZ/1PH	230VAC/60HZ/1PH
Motor	1HP	1HP	2HP
Amps	15	15	15 - 18
RPM	3450	3450	3450
PSI	2610	2610	2755
Tank Capacity	1.5 Gallon	3.5 Gallon	3.5 Gallon

LIFT CYLINDERS, CABLES & HOSES



TP9K SERIES CYLINDERS

- TP9-1024
- CHAIN OVER
- 3/8" NPT PORT
- SEAL KIT – TP9-1057-F

TP9K-X SERIES CYLINDERS

- TP9KX-1024
- CHAIN OVER
- BANJO STYLE PORT
- SEAL KIT – TP9-1057

TP11KAC (CHAIN) CYLINDERS

- TP11KAC-3024
- CHAIN OVER CYLINDER
- 3/8" PORT
- SEAL KIT – TP11KAC-3090-N
- SEAL KIT – TP11KAC-3090

TP12KF SERIES CYLINDERS

- TP15KC-K-8016
- CHAIN OVER
- 3/8" NPT PORT
- SEAL KIT –

TP15K SERIES CYLINDERS

- TP15KC-K-8016
- CHAIN OVER
- 3/8" NPT PORT
- SEAL KIT –

TP15KCX SERIES CYLINDERS

- TP12/TP15KX-8016
- CHAIN OVER
- BANJO PORT
- SEAL KIT –

FP7K STORAGE CABLES

- FP7K-4007 – 8' 4-1/4"
- FP7K-4008 – 13' 5-1/2"
- FP7K-4009 – 26' 2-1/2"
- FP7K-4010 – 21' 1-1/4"

FP7K-XLT STORAGE CABLES

- FP7K-4049 – 9' 3-3/8"
- FP7K-4050 – 14' 5-3/4"
- FP7K-4051 – 28' 10-5/8"
- FP7K-4052 – 23' 9-1/8"

FP8KDS/DX STORAGE CABLES

- FP8K-DS/DX-094 – 26' 9-7/8"
- FP8K-DS/DX-095 – 22' 1-3/4"
- FP8K-DS/DX-096 – 8' 10-5/8"
- FP8K-DS/DX-097 – 13' 6-3/8"

TP9KAC / TP9KF HOSES

- TP9-1033 – 65"
- FP9-1042 – 28' 6"

TP9KF HOSES

- TP9-1033 – 65"
- FP9-1034 – 110"

TP9KACX / TP9KSCX HOSES

- TP9KACX-068 – 341.7"
- TP9KACX-070 – 14.1"
- TP9K-077 – 56.3"

TP9KFX HOSES

- TP9KFX-053 – 14.1"
- TP9KFX-055 – 56.3"
- TP9KFX-069 – 111"

**ADDITIONAL CYLINDERS, CABLES, HOSES
AVAILABLE CALL FOR MORE!**

CONSUMABLE PAINT BOOTH PARTS



PAINT SPRAY BOOTH EXHAUST FILTERS, INTAKE FILTERS & WIRE GRIDS



PSBSDD-PA203A
AFC EXHAUST, 15 GRAM, FIBERGLASS
20" ARRESTOR ROLL MEDIA



PSBAFCF-CT1012
AFC EXHAUST, PAINT ARRESTOR
HOLDING GRIDS W/ NAILS 20" X 20"



PSBAFCF-GA10-100
AFC EXHAUST, 15 GRAM, FIBERGLASS
ARRESTOR PAD 20" X 20" X 2"



PSBSDD-PF2050-16A
AFC INTAKE PREFILTER PANEL 20" X 50"

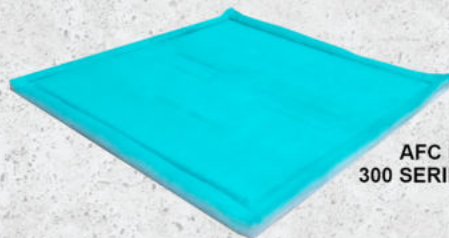

PSBAFCF-320
AFC INTAKE TACKY 20" X 20"
300 SERIES PANEL FILTER W/ FRAME

REPLACEMENT PARTS



TWO POST EQUALIZATION CABLES
FOUR POST SERVICE/ALIGNMENT LIFT CABLES
FOUR POST STORAGE LIFT CABLES

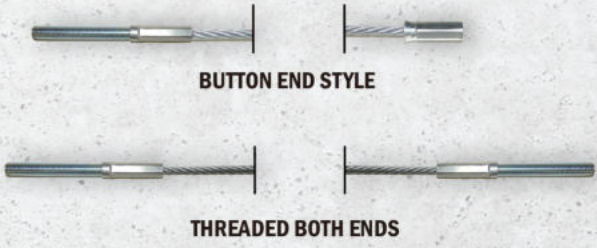

- CYLINDER-2536** 2.5 x 36
- CYLINDER-3036** 3.0 x 36
- CYLINDER-2069** 2.0 x 69
- CYLINDER-3070** 3.0 x 70
- CYLINDER-3080** 3.0 x 80
- CYLINDER-3572** 3.5 x 72
- CYLINDER-4072** 4.0 x 72
- CYLINDER-5560** 5.5 x 60



- TP7KAC-62** TP7KAC CYLINDER
- TP9-1024** TP9KAC/TP9KF CYLINDER
- TP9KX-1024** TP9KACX/TP9KFX CYLINDER
- TP11KAC-3024** TP11KAC CYLINDER
- TP11KACD-008** TP11KAC-D CYLINDER
- TP15KC-K-8016** TP12K-F/TP15KC-K CYLINDER
- FP12K-K-025** FP12K-K CYLINDER
- FP14K-5006** FP14K/FP14KA CYLINDER
- FP14K0A-052** FP14K0-A CYLINDER
- FP7K-4039** FP7K/8K/9K CYLINDER
- FP7K-4047** FP7K-XLT/8K-XLT CYLINDER
- MR6K-48-18** MR6K-48 CYLINDER (RH)
- MR6K-48-19** MR6K-48 CYLINDER (LH)
- MR6K-38-032** MR6K-38 CYLINDER
- M-1500C-033** M-1500C-HR CYLINDER

ADDITIONAL PARTS AVAILABLE CALL FOR MORE!

TUXEDO®

Distributors, LLC.
Automotive Equipment & Accessories



IDEAL™

A DIVISION OF TUXEDO DISTRIBUTORS, LLC

LAUNCH

DURO™

HYDRAULICS

20 YEARS OF SERVICE AND COUNTING:

Tuxedo Distributors has multiple satellite locations strategically placed to maximize freight savings and minimize damage!

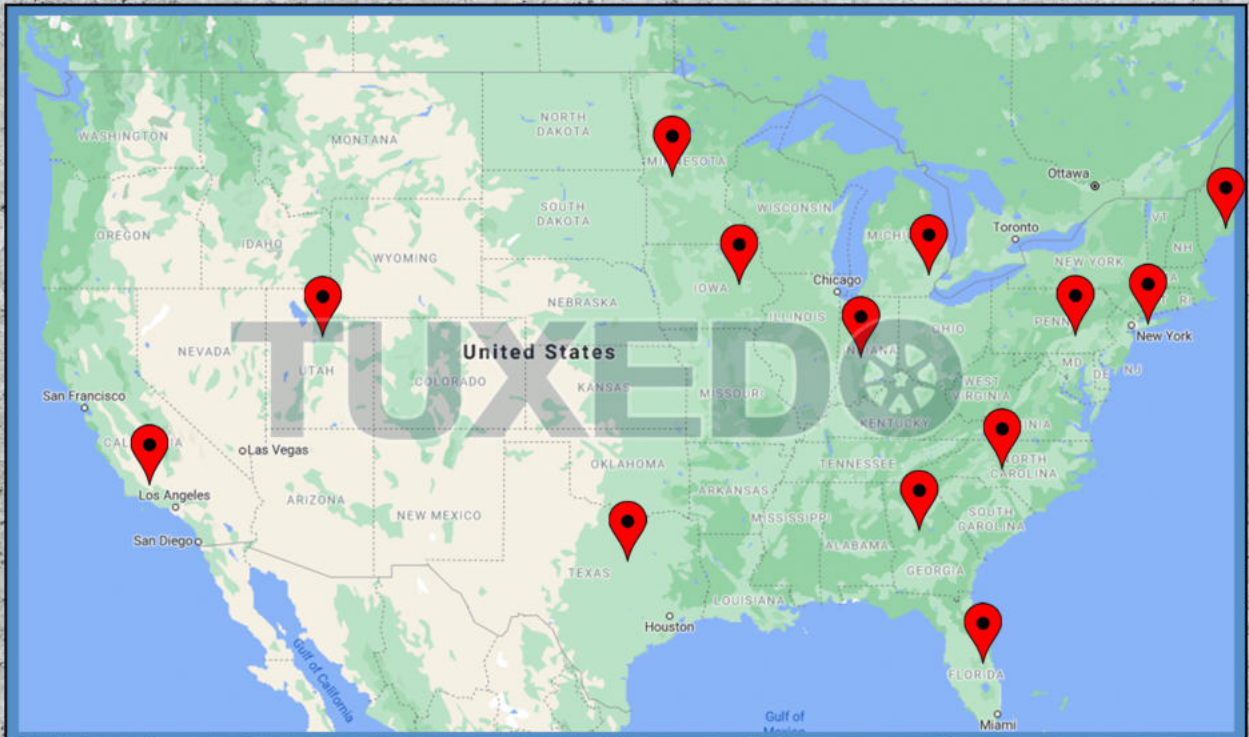

FOLLOW US ON OUR SOCIAL MEDIA!



SPEED COUNTS!